



Planning Commission Staff Report

Meeting Date: October 1, 2019

Agenda Item: 8B

TENTATIVE SUBDIVISION MAP CASE NUMBER: WTM19-004 Falcon Ridge North

BRIEF SUMMARY OF REQUEST:

To approve a tentative map to allow the subdivision of 6.1 acres into a 52 lot common open space development with townhouses.

STAFF PLANNER:

Planner's Name:

Julee Olander

Phone Number:

775.328.3627

E-mail:

jolander@washoecounty.us

CASE DESCRIPTION

For possible action, hearing, and discussion to approve a tentative map to allow the subdivision of 6.19 acres into a 52 lot common open space development. The overall density of the project would be 8.4 dwelling units per acre.

Applicant/Property Owner: Falcon Ridge by Desert Wind LP

Location: at terminus of Falcon Rock Lane

APN: 035-721-02

Parcel Size: 6.19 acres

Master Plan: Urban Residential (UR)
Regulatory Zone: Low Density Urban (LDU) (maximum density of 10 units per acre)

Area Plan: Sun Valley

Citizen Advisory Board: Sun Valley

Development Code: Article 408, Common Open Space Development and Article 608, Tentative Subdivision Maps

Commission Districts: 3 – Commissioner Jung & 5 – Commissioner Herman

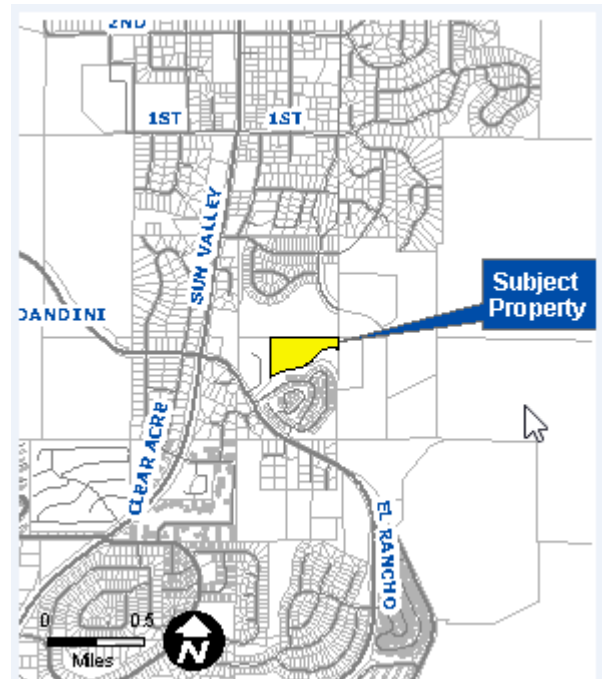

STAFF RECOMMENDATION

APPROVE

APPROVE WITH CONDITIONS

DENY

POSSIBLE MOTION

I move that, after giving reasoned consideration to the information contained in the staff report and information received during the public hearing, the Washoe County Planning Commission approve, with the conditions included as Exhibit A to this matter, Tentative Subdivision Map Case Number WTM19-004 for Falcon Ridge North by Desert Wind LP, having made all ten findings in accordance with Washoe County Code Section 110.608.25:

(Motion with Findings on Page 10)

Staff Report Contents

Tentative Subdivision Map 3

Site Plan 5

Project Evaluation 5

Traffic..... 6

Washoe County School District..... 6

Site Characteristics 6

Infrastructure/ Public Facilities and Services..... 7

Sun Valley Citizen Advisory Board (SVCAB)..... 7

Reviewing Agencies..... 7

Washoe County Master Plan..... 8

Sun Valley Area Plan 9

Staff Comment on Required Findings 9

Motion 10

Appeal Process..... 11

Exhibits Contents

Conditions of Approval.....Exhibit A

Agency Review LettersExhibit B

Public Notice Map Exhibit C

Approved Unbuilt Map..... Exhibit D

Falcon Ridge Specific PlanExhibit E

Project ApplicationExhibit F

Tentative Subdivision Map

The purpose of a tentative subdivision map is:

- To allow the creation of saleable lots;
- To implement the Washoe County Master Plan, including the area plans, and any specific plans adopted by the County;
- To establish reasonable standards of design and reasonable procedures for subdivision and re-subdivision in order to further the orderly layout and use of land and insure proper legal descriptions and monumenting of subdivided land; and;
- To safeguard the public health, safety and general welfare by establishing minimum standards of design and development for any subdivision platted in the unincorporated area of Washoe County.

If the Planning Commission grants an approval of the tentative subdivision map, that approval is subject to conditions of approval. Conditions of approval are requirements that need to be completed during different stages of the proposed project. Those stages are typically:

- Prior to recordation of a final map.
- Prior to obtaining a final inspection and/or a certificate of occupancy on a structure.
- Prior to the issuance of a business license or other permits/licenses.
- Some conditions of approval are referred to as “operational conditions.” These conditions must be continually complied with for the life of the project.

The conditions of approval for Tentative Subdivision Map Case Number WTM19-004 are attached to this staff report and will be included with the action order.

The subject property includes regulatory zones of Low Density Urban (LDU). The maximum number of residences allowed, based upon the existing zoning is 61 units on 6.1 acres.

The applicant is requesting to create 52 residential lots. This is permissible based upon the approval of a tentative subdivision map by Washoe County and compliance with all generally applicable provisions of the Development Code.

Article 406, Common Open Space Development, allows general development standards to be varied with the approval of a tentative subdivision map.

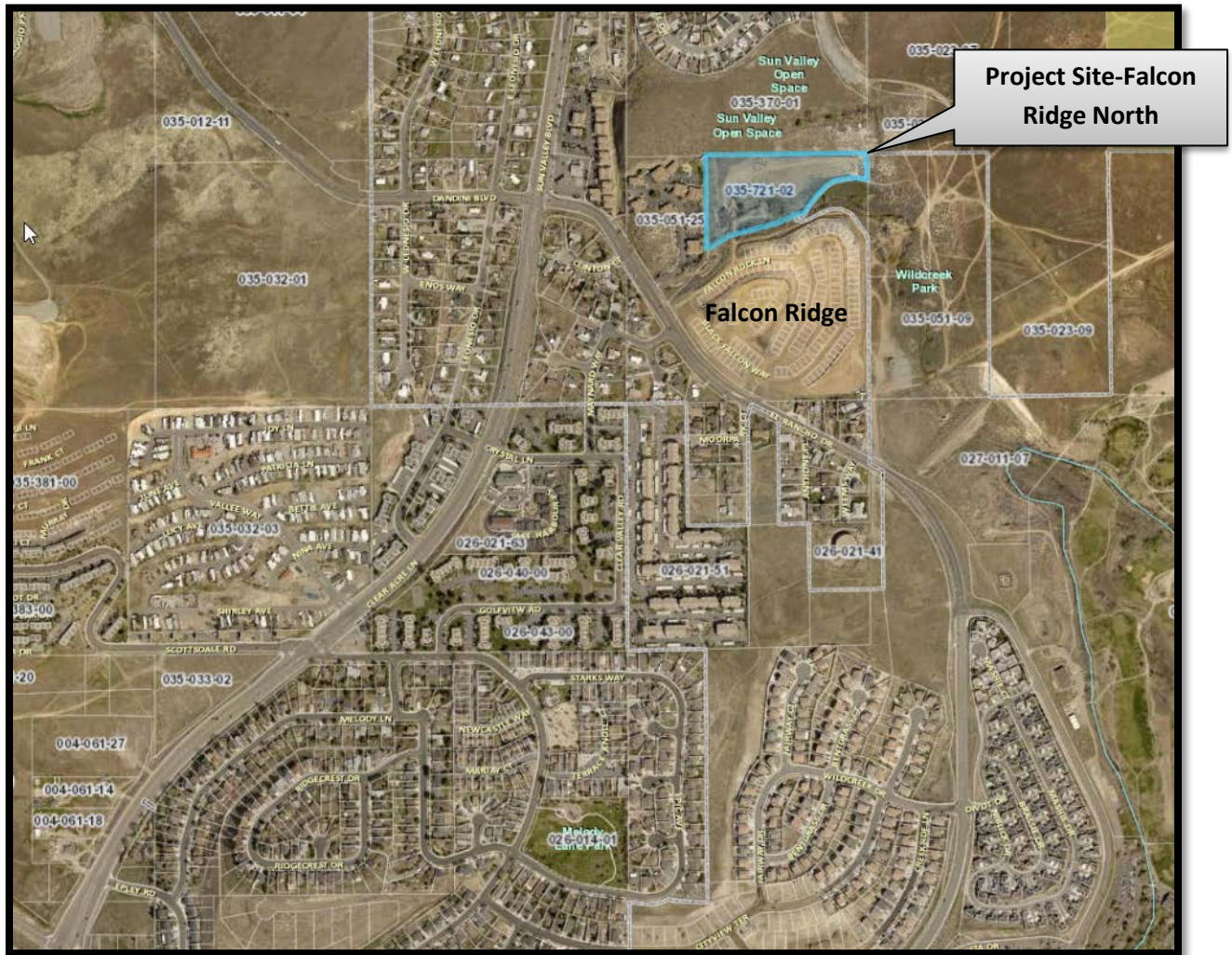

Vicinity Map



Site Plan

Project Evaluation

The applicant is requesting to develop Falcon Ridge North a 6.19 acre site as a common open space development with 52 single family lots. The development will be similar to the property to the south, Falcon Ridge, which has the same owner. Both Falcon Ridge North and Falcon Ridge are part of the Falcon Ridge Specific Plan (SP), which is a part of the Sun Valley Area Plan, appendix B. The purpose of the plan is to “provide for a high quality multi-family and attached single family residential project that respects the natural site features through careful placement of homes, preservation of open space, and hillside sensitive grading techniques. Additionally, the SP will provide for architectural, landscaping, and setback standards to ensure that Falcon Ridge complements adjacent developments.” The plan development standards includes utilities, trails, structure design, grading, building siting, recreational amenities, landscaping, open space/buffers, traffic access, parking, fencing, air quality, archeological, wildlife and fisheries protection, fire protection and natural hazards. These standards include specific requirements for color palettes for the homes, preservation of natural features, landscaping material, number of parking spaces, and other requirements. Falcon Ridge North will comply with these requirements.

The parcel is master planned Urban Residential (UR) and has a regulatory zone of Low Density Urban (LDU). The LDU zoning allows 10 lots per acre for single family. The applicant is proposing an overall density of 8.4 lots per acre with 3.55 acres of undeveloped open space. The common area is located between the proposed houses and the property line and in between the internally located houses, with the largest area is in the northeast corner of the site (See the Site Plan). The common area allows the site to be accessible to surrounding areas including Falcon Ridge to the south, the Sun Valley Open Space to the north and Wildcreek Park to the southeast. The Falcon Ridge SP has designated a trail between Falcon Ridge and Falcon Ridge North. Staff is recommending a walking trail in the common area to link to the surrounding parcels.

The lots will vary in size from 960 square feet to 1,477 square feet. The lots along the northern and western property line will be graded into the hillside. The houses will be comparable to the houses in the approved Falcon Ridge development. There will be six-foot wood fence for the side and rear yards for each lot. The project is planned to be built as a single phase. Guest parking will be provided in different locations with a total of 15 guest parking spaces.

A homeowners association (HOA) will be created for all of Falcon Ridge with the approval of the first final map. The HOA will be responsible for maintaining the common area along with any planned covenants, conditions and restrictions (CCR's). There will be two private roadways through Falcon Ridge North. The main road will have sidewalks on both sides of the street and the other street will only have sidewalks on the north side where houses are located. The HOA will be responsible for maintenance of the roads and sidewalks. A gate is planned for the Falcon Ridge development and will serve this project as well.



Proposed Building Elevations

Traffic

The main access will be through the approved Falcon Ridge development to the south on Falcon Ridge Lane from El Rancho Drive. The size of the project will not have significant impact to the area traffic. The 52 houses are anticipated to generate 302 average daily trips, with 23 trips during the AM peak and 27 trips during the PM peak. A traffic light is planned at the intersection of El Rancho and Falcon Ridge Lane per the Falcon Ridge Specific Plan with the recordation of the 143rd dwelling unit. Therefore, staff will require the installation of traffic light prior to the recordation of any lots within the Falcon Ridge North development.

Washoe County School District

The proposed development is zoned for Allen Elementary School, Desert Skies Middle School and Hug High School. According to the Washoe County School District, the 52 proposed units would generate approximately two students at the elementary school, one student at the middle school and one student at the high school. All three schools are currently under capacity and additional students from the proposed development should not change this status. (See Exhibit B – Agency Review Letters).

Site Characteristics

The subject property is currently vacant with high desert vegetation and some trees in the southern portion of the parcel along the drainage channel. The site has been graded with prior permits in the past and has dirt piles from the ongoing construction of Falcon Ridge. There is a drainage channel in the southern portion of the parcel and the applicant has indicated that it will be retained and incorporated into the common area. The drainage channel is both natural and

engineered, managing water runoff from the site. A detention pond is proposed to collect water runoff from the site and detain water from the 5 and 100-year storm events. The detention pond will be located directly north of the drainage area just south of the proposed development.

The parcel to the north is owned by Washoe County and has a regulatory zoning of Medium Density Suburban (MDS) and General Rural (GR). The properties to the east are owned by City of Sparks and are part of Wildcreek Park with a regulatory zoning of Public Facility (PF). The parcel to the west is developed residentially and has a regulatory zone of Medium Density Urban (MDU) and the property to the south is Falcon Ridge and has a regulatory zone of Low Density Urban (LDU).

Infrastructure/ Public Facilities and Services

The site is located in an area with existing infrastructure and all municipal services are either in place or can be easily established. A letter from TMWA was included in the application indicating the site is in TMWA service area and TMWA will supply water service to the site by extending the existing service from Falcon Ridge from the south. The application also, provided information concerning sewer service, which will be provided by Washoe County by extending the system already installed in the Falcon Ridge development to the south. The connection to sewer service will be through Falcon Ridge development to the south. The closest fire station is Truckee Meadows fire station 45 and Washoe County sheriff will provide service to the site.

Sun Valley Citizen Advisory Board (SVCAB)

The Sun Valley CAB did not meet during the month of September and the applicant was not able to present to the CAB. The CAB was notified of the application, however no comments were received.

Reviewing Agencies

- Washoe County Community Services Department
 - Engineering and Capital Projects
 - Planning and Building
 - Parks and Open Space
 - Water Management
- Washoe County Health District
 - Air Quality
 - Environmental Health
- State of Nevada
 - Division of Environmental Protection
 - Department of Water Resources
- Truckee Meadows Fire Protection District
- City of Sparks Fire
- Regional Transportation Commission
- Washoe County Sheriff
- Washoe County School District
- Washoe-Storey Conservation District
- U.S. Postal Service

The following agencies/departments submitted a response to the proposed tentative subdivision map. A summary of each agency's comments and/or recommended conditions of approval and their contact information are provided. The conditions of approval document is attached to this staff report and will be included with the action order should the Planning Commission approve the tentative subdivision map application.

- Washoe County Planning and Building Division addressed common area standards and other features associated with the project.
Contact: Julee Olander, 775.328.3627, jolander@washoecounty.us
- Washoe County Engineering and Capital Projects addressed land development, sewer, traffic and other associated matters.
Contact: Leo Vesely, 775.328.2040, lvesely@washoecounty.us
Contact: Tim Simpson, 775.328.2310, tsimpson@washoecounty.us
Contact: Mitchell Fink, 775.328.2050, mfink@washoecounty.us
- Washoe County Planning and Building Division – Park Planner addressed public trail easement.
Contact: Sophia Kirschenman, 775.328.3623, skirschenman@washoecounty.us
- Washoe County Water Management Planner Coordinator addressed water rights for the site.
Contact: Vahid Behmaram, 775.328.3622, vbehmaram@washoecounty.us
- Nevada Division of Water Resources provided information for water rights.
Contact: Steve Shell, 775.684.2800, sshell@ndep.gov
- Washoe County School District provided information on current and anticipated capacity at schools.
Contact: Brett Rodela, 775.325.8303, brett.rodela@washoeschools.net
- Washoe-Storey Conservation District provided information concerning drainage and detention basins.
Contact: Tyler Shaffer, 775.857.8500 ext. 131, shafferjam51@gmail.com

Washoe County Master Plan

Land Use and Transportation Element

Goal Three: The majority of growth and development occurs in existing or planned communities, utilizing smart growth practices.

Policy LUT.3.1: Require timely, orderly, and fiscally responsible growth that is directed to existing suburban character management areas (SCMAs) within the Area Plans as well as to growth areas delineated within the Truckee Meadows Service Area (TMSA).

Staff Comment: The subject property is within the Suburban Character Management Area (SCMA) of the Sun Valley Area Plan, which has been identified as the area for residential growth.

Housing Element

Goal One: Remove Regulatory Barriers to increase the availability of affordable and workforce housing for all.

Policy 1.5: Encourage development at higher densities where appropriate.

Staff Comment: Common open space development will increase the density on the site.

Goal Seven: Promote Homeownership opportunities.

Policy 7.4: Promote home ownership as a community asset.

Staff Comment: The development will be a single family development and will promote home ownership.

Sun Valley Area Plan

Appendix B- Falcon Ridge Specific Plan (SP)

Staff Comment: The application is the final development of the Falcon Ridge SP and will meet all requirements that are included in the SP (See Exhibit E).

Staff Comment on Required Findings

WCC Section 110.608.25 of Article 608, *Tentative Subdivision Maps*, requires that all of the following findings be made to the satisfaction of the Washoe County Planning Commission before granting approval of the abandonment request. Staff has completed an analysis of the application and has determined that the proposal is in compliance with the required findings as follows.

- 1) Plan Consistency. That the proposed map is consistent with the Master Plan and any specific plan.

Staff Comment: The proposed tentative map is consistent with the goals and policies of the Master Plan and the Sun Valley Area Plan.

- 2) Design or Improvement. That the design or improvement of the proposed subdivision is consistent with the Master Plan and any specific plan.

Staff Comment: The proposed tentative map meets all of the density, lot size and common open space criteria of the Master Plan and the Sun Valley Area Plan.

- 3) Type of Development. That the site is physically suited for the type of development proposed.

Staff Comment: The site is physically suited for the type of development proposed and the site can accommodate the type of development proposed.

- 4) Availability of Services. That the subdivision will meet the requirements of Article 702, Adequate Public Facilities Management System.

Staff Comment: The proposed subdivision will meet the requirements of Article 702, Adequate Public Facilities Management System; impacts associated with the proposed subdivision will be appropriately mitigated, based upon the imposition of appropriate conditions of approval as included at Exhibit A to this report.

- 5) Fish or Wildlife. That neither the design of the subdivision nor any proposed improvements is likely to cause substantial environmental damage, or substantial and avoidable injury to any endangered plant, wildlife or their habitat.

Staff Comment: The proposed improvements will not cause substantial environmental damage or harm to endangered plants, wildlife or their habitat.

- 6) Public Health. That the design of the subdivision or type of improvement is not likely to cause significant public health problems.

Staff Comment: Due to the location and design of the subdivision and type of improvements, this development is not likely to cause significant public health problems.

- 7) Easements. That the design of the subdivision or the type of improvements will not conflict with easements acquired by the public at large for access through, or use of property within, the proposed subdivision.

Staff Comment: The proposed development has taken all easements into consideration and will not conflict with the easements in regards to utility purposes or public access, etc.

- 8) Access. That the design of the subdivision provides any necessary access to surrounding, adjacent lands and provides appropriate secondary access for emergency vehicles.

Staff Comment: The design of the subdivision provides access to surrounding adjacent lands and provides appropriate secondary access for emergency vehicles.

- 9) Dedications. That any land or improvements to be dedicated to the County is consistent with the Master Plan.

Staff Comment: In the event that the roads or other lands are dedicated to the County, the lands will be improved such that they are consistent with the Master Plan and/or built to County standards.

- 10) Energy. That the design of the subdivision provides, to the extent feasible, for future passive or natural heating or cooling opportunities in the subdivision.

Staff Comment: To the extent feasible, the development will include building materials to allow for passive or natural heating and cooling opportunities. Additionally, the homes will be oriented in such a way to take advantage of passive/natural heating and cooling opportunities.

Recommendation

Those agencies which reviewed the application recommended conditions in support of approval of the project. Therefore, after a thorough analysis and review, Tentative Subdivision Map Case Number WTM19-004 is being recommended for approval with conditions. Staff offers the following motion for the Board's consideration.

Motion

I move that, after giving reasoned consideration to the information contained in the staff report and information received during the public hearing, the Washoe County Planning Commission approve, with the conditions included as Exhibit A to this matter, Tentative Subdivision Map Case Number WTM19-004 for Falcon Ridge by Desert Wind LP, having made all ten findings in accordance with Washoe County Code Section 110.608.25:

- 1) Plan Consistency. That the proposed map is consistent with the Master Plan and any specific plan;
- 2) Design or Improvement. That the design or improvement of the proposed subdivision is consistent with the Master Plan and any specific plan;
- 3) Type of Development. That the site is physically suited for the type of development proposed;
- 4) Availability of Services. That the subdivision will meet the requirements of Article 702, Adequate Public Facilities Management System;
- 5) Fish or Wildlife. That neither the design of the subdivision nor any proposed improvements is likely to cause substantial environmental damage, or substantial and avoidable injury to any endangered plant, wildlife or their habitat;
- 6) Public Health. That the design of the subdivision or type of improvement is not likely to cause significant public health problems;
- 7) Easements. That the design of the subdivision or the type of improvements will not conflict with easements acquired by the public at large for access through, or use of property within, the proposed subdivision;

- 8) Access. That the design of the subdivision provides any necessary access to surrounding, adjacent lands and provides appropriate secondary access for emergency vehicles;
- 9) Dedications. That any land or improvements to be dedicated to the County is consistent with the Master Plan; and
- 10) Energy. That the design of the subdivision provides, to the extent feasible, for future passive or natural heating or cooling opportunities in the subdivision.

Appeal Process

Planning Commission action will be effective 10 calendar days after the written decision is filed with the Secretary to the Planning Commission, unless the action is appealed to the Washoe County Board of County Commissioners, in which case the outcome of the appeal shall be determined by the Washoe County Board of County Commissioners. Any appeal must be filed in writing with the Planning and Building Division within 10 calendar days from the date the written decision is filed with the Secretary to the Planning Commission and mailed to the applicant.

Applicant/Owner: Falcon Ridge by Desert Wind LP, 500 California Avenue, Reno, NV 89509, email: cf@desertwindhomes.com

Representatives: Rubicon Design Groups, 1610 Montclair Avenue, Suite B, Reno, NV 89509, email: dwilson@rubicondesigngroup.com



Conditions of Approval

Tentative Subdivision Map Case Number WTM19-004

The project approved under Tentative Subdivision Map Case Number WTM19-004 shall be carried out in accordance with the conditions of approval granted by the Planning Commission on October 1, 2019. Conditions of approval are requirements placed on a permit or development by each reviewing agency. These conditions of approval may require submittal of documents, applications, fees, inspections, amendments to plans, and more. These conditions do not relieve the applicant of the obligation to obtain any other approvals and licenses from relevant authorities required under any other act.

Unless otherwise specified, all conditions related to the approval of this tentative subdivision map shall be met or financial assurance must be provided to satisfy the conditions of approval prior to the recordation of a final parcel map. The agency responsible for determining compliance with a specific condition shall determine whether the condition must be fully completed or whether the applicant shall be offered the option of providing financial assurance. All agreements, easements, or other documentation required by these conditions shall have a copy filed with the County Engineer and the Planning and Building Division.

Compliance with the conditions of approval related to this tentative subdivision map is the responsibility of the applicant, his/her successor in interest, and all owners, assignees, and occupants of the property and their successors in interest. Failure to comply with any of the conditions imposed in the approval of the tentative parcel map may result in the institution of revocation procedures.

Washoe County reserves the right to review and revise the conditions of approval related to this tentative subdivision map should it be determined that a subsequent license or permit issued by Washoe County violates the intent of this approval.

For the purpose of conditions imposed by Washoe County, “may” is permissive and “shall” or “must” is mandatory.

Conditions of approval are usually complied with at different stages of the proposed project. Those stages are typically:

- Prior to recordation of a final map.
- Prior to obtaining a final inspection and/or a certificate of occupancy.
- Prior to the issuance of a business license or other permits/licenses.
- Some “conditions of approval” are referred to as “operational conditions.” These conditions must be continually complied with for the life of the project.

STANDARD Nevada Revised Statutes 278.349	CONSIDERATIONS	FOR	SUBDIVISIONS
---	-----------------------	------------	---------------------

Pursuant to NRS 278.349, when contemplating action on a tentative subdivision map, the governing body, or the planning commission if it is authorized to take final action on a tentative map, shall consider:

- (a) Environmental and health laws and regulations concerning water and air pollution, the disposal of solid waste, facilities to supply water, community or public sewage disposal and, where applicable, individual systems for sewage disposal;
- (b) The availability of water which meets applicable health standards and is sufficient for the reasonably foreseeable needs of the subdivision;
- (c) The availability and accessibility of utilities;
- (d) The availability and accessibility of public services such as schools, police and fire protection, transportation, recreation and parks;
- (e) Conformity with the zoning ordinances and master plan, except that if any existing zoning ordinance is inconsistent with the master plan, the zoning ordinance takes precedence;
- (f) General conformity with the governing body's master plan of streets and highways;
- (g) The effect of the proposed subdivision on existing public streets and the need for new streets and highways to serve the subdivision;
- (h) Physical characteristics of the land such as floodplain, slope and soil;
- (i) The recommendations and comments of those entities reviewing the tentative map pursuant to NRS 278.330 and 278.335; and
- (j) The availability and accessibility of fire protection, including, but not limited to, the availability and accessibility of water and services for the prevention and containment of fires, including fires in wild lands.

FOLLOWING ARE CONDITIONS OF APPROVAL REQUIRED BY THE REVIEWING AGENCIES. EACH CONDITION MUST BE MET TO THE SATISFACTION OF THE ISSUING AGENCY.

Washoe County Planning and Building Division

1. The following conditions are requirements of the Planning and Building Division, which shall be responsible for determining compliance with these conditions.

Contact: Julee Olander, Planner, 775.328.3627, jolander@washoecounty.us

- a. The applicant shall demonstrate substantial conformance to the plans approved as part of this tentative parcel map.
- b. The subdivision shall be in substantial conformance with the provisions of Washoe County Development Code Article 604, Design Requirements, and Article 608, Tentative Subdivision Maps.
- c. Final maps and final construction drawings shall comply with all applicable statutes, ordinances, rules, regulations and policies in effect at the time of submittal of the tentative map or, if requested by the developer and approved by the applicable agency, those in effect at the time of approval of the final map.
- d. In accordance with NRS 278.360, the sub-divider shall present to Washoe County a final map, prepared in accordance with the tentative map, for the entire area for which a tentative map has been approved, or one of a series of final maps, each covering a portion of the approved tentative map, within four years after the date of approval of the tentative map or within one year of the date of approval for subsequent final maps. On subsequent final maps, that date may be extended by two years if the extension request is received prior to the expiration date.

- e. Final maps shall be in substantial compliance with all plans and documents submitted with and made part of this tentative map request, as may be amended by action of the final approving authority.
- f. All final maps shall contain the applicable portions of the following jurat:

THE TENTATIVE MAP FOR WTM19-004(Falcon Ridge North) WAS APPROVED BY THE WASHOE COUNTY PLANNING COMMISSION ON OCTOBER 1, 2019.

THIS FINAL MAP, MAP NAME AND UNIT/PHASE #, MEETS ALL APPLICABLE STATUTES, ORDINANCES AND CODE PROVISIONS, IS IN SUBSTANTIAL CONFORMANCE WITH THE TENTATIVE MAP, AND ALL CONDITIONS HAVE BEEN MET.

[Omit the following paragraph if this is the first and last (only) final map.]

THE NEXT FINAL MAP FOR <TM CASE NUMBER> MUST BE APPROVED AND ACCEPTED FOR RECORDATION BY THE PLANNING AND BUILDING DIRECTOR ON OR BEFORE THE EXPIRATION DATE, THE _____ DAY OF _____, 20____, OR AN EXTENSION OF TIME FOR THE TENTATIVE MAP MUST BE APPROVED BY THE WASHOE COUNTY PLANNING COMMISSION ON OR BEFORE SAID DATE.

THIS FINAL MAP IS APPROVED AND ACCEPTED FOR RECORDATION THIS _____ DAY OF _____, 20____ BY THE PLANNING AND BUILDING DIRECTOR. THE OFFER OF DEDICATION FOR STREETS, SEWERS, ETC. IS REJECTED AT THIS TIME, BUT WILL REMAIN OPEN IN ACCORDANCE WITH NRS CHAPTER 278.

MOJRA HAUENSTEIN, DIRECTOR
PLANNING AND BUILDING

Jurat for ALL SUBSEQUENT FINAL MAPS

THE TENTATIVE MAP for <TM CASE NUMBER> APPROVED <denied> BY THE WASHOE COUNTY PLANNING COMMISSION ON <date>. [If the TM had been appealed to the BCC --- Add:] THE WASHOE COUNTY COMMISSION APPROVED THE TENTATIVE MAP ON APPEAL ON <date>.

THE FIRST FINAL MAP FOR THIS TENTATIVE MAP WAS APPROVED AND ACCEPTED FOR RECORDATION ON <date of Planning and Building Director's signature on first final map>. [Omit the following if second map.] THE MOST RECENTLY RECORDED FINAL MAP, <subdivision name and prior unit/phase #> FOR THIS TENTATIVE MAP WAS APPROVED AND ACCEPTED FOR RECORDATION ON <date of Planning and Building Director's

signature on most recent final map> [If an extension has been granted after that date – add the following]: A TWO YEAR EXTENSION OF TIME FOR THE TENTATIVE MAP WAS APPROVED BY THE WASHOE COUNTY PLANNING COMMISSION ON <date of last Planning Commission action to extend the tentative map>.

THIS FINAL MAP, <subdivision name and unit/phase #>, MEETS ALL APPLICABLE STATUTES, ORDINANCES AND CODE PROVISIONS; IS IN SUBSTANTIAL CONFORMANCE WITH THE TENTATIVE MAP; AND ALL CONDITIONS HAVE BEEN MET.

[Omit the following paragraph if this is the last final map.]

THE NEXT FINAL MAP FOR <TM CASE NUMBER> MUST BE APPROVED AND ACCEPTED FOR RECORDATION BY THE PLANNING AND BUILDING DIRECTOR ON OR BEFORE THE EXPIRATION DATE, THE _____ DAY OF _____, 20____, <add two years to the current expiration date unless that date is more than two years away> OR AN EXTENSION OF TIME FOR THE TENTATIVE MAP MUST BE APPROVED BY THE WASHOE COUNTY PLANNING COMMISSION ON OR BEFORE SAID DATE.

<Insert Merger and Re-subdivision option as applicable>

THIS FINAL MAP IS APPROVED AND ACCEPTED FOR RECORDATION THIS ____ DAY OF _____, 20____ BY THE WASHOE COUNTY PLANNING AND BUILDING DIRECTOR. THE OFFER OF DEDICATION FOR <streets, sewers> IS REJECTED AT THIS TIME, BUT WILL REMAIN OPEN IN ACCORDANCE WITH NRS CHAPTER 278.

MOJRA HAUENSTEIN, DIRECTOR,
PLANNING AND BUILDING DIVISION

- g. A note shall be placed on all grading plans and construction drawings stating:

NOTE

Should any cairn or grave of a Native American be discovered during site development, work shall temporarily be halted at the specific site and the Sheriff’s Office as well as the State Historic Preservation Office of the Department of Conservation and Natural Resources shall be immediately notified per NRS 383.170.

- h. The final map shall designate faults that have been active during the Holocene epoch of geological time, and the final map shall contain the following note:

NOTE

No habitable structures shall be located on a fault that has been active during the Holocene epoch of geological time.

- i. The developer and all successors shall direct any potential purchaser of the site to meet with the Planning and Building Division to review conditions of approval prior to the final sale of the site. Any subsequent purchasers of the site shall notify the Planning and Building Division of the name, address, telephone number and contact person of the new purchaser within thirty (30) days of the final sale.
- j. The applicant shall submit complete construction plans and building permits shall be issued within two years from the date of approval by Washoe County. The applicant shall complete construction within the time specified by the building permits. Compliance with this condition shall be determined by the Planning and Building Division.
- k. Failure to comply with the conditions of approval shall render this approval null and void.
- l. The common open space owned by the homeowners association (HOA) shall be noted on the final map as "common open space" and the related deed of conveyance shall specifically provide for the preservation of the common open space in perpetuity. The deed to the open space and common area shall reflect perpetual dedication for that purpose. The deed shall be presented with the CC&Rs for review by Planning and Building staff and the District Attorney.
- m. The developer shall establish and construct walking trails with decomposed granite in the common areas linking to surrounding parcels to provide access and connectivity that will be maintained by the homeowners association.
- n. Construction activities shall be limited to the hours between 7AM and 7PM on Mondays, Tuesdays, Wednesdays, Thursdays, Fridays and Saturdays. Construction activities shall be limited to the hours between 8AM and 5PM on Sundays and no noise shall exceed 65 dB at the property line.
- o. The applicant shall construct a traffic signal at the intersection of the project entrance, El Rancho Drive and Moorpark Court, to be funded 100% by the developer prior to the issuance certificate of occupancy of the 143rd unit of Falcon ridge and Falcon Ridge North.
- p. Conditions, covenants, and restrictions (CC&Rs), including any supplemental CC&Rs, shall be submitted to Planning and Building staff for review and subsequent forwarding to the District Attorney for review and approval. The final CC&Rs shall be signed and notarized by the owner(s) and submitted to Planning and Building with the recordation fee prior to the recordation of the final map. The CC&Rs shall require all phases and units of the subdivision approved under this tentative map to be subject to the same CC&Rs. Washoe County shall be made a party to the applicable provisions of the CC&Rs to the satisfaction of the District Attorney's Office. Said CC&Rs shall specifically address the potential for liens against the properties and the individual property owners' responsibilities for the funding of maintenance, replacement, and perpetuation of the following items, at a minimum:
 1. Maintenance of public access easements, common areas, and common open spaces. Provisions shall be made to monitor and maintain, for a period of three (3) years regardless of ownership, a maintenance plan for the common open space area. The maintenance plan for the common open space area shall, as a minimum, address the following:
 - a. Vegetation management;
 - b. Watershed management;
 - c. Debris and litter removal;
 - d. Fire access and suppression; and
 - e. Maintenance of public access and/or maintenance of limitations to public access.

2. All drainage facilities and roadways not maintained by Washoe County shall be privately maintained and perpetually funded by the homeowners association.
3. All open space identified as common area on the final map shall be privately maintained and perpetually funded by the homeowners association. The deed to the open space and common area shall reflect perpetual dedication for that purpose. The maintenance of the common areas and related improvements shall be addressed in the CC&Rs to the satisfaction of the District Attorney's Office.
4. The project and adjacent to undeveloped land shall maintain a fire fuel break of a minimum 30 feet in width until such time as the adjacent land is developed.
6. All outdoor lighting on buildings and streets within the subdivision shall be down-shielded.
7. No motorized vehicles shall be allowed on the platted common area.
8. Washoe County will not assume responsibility for maintenance of the private street system of the development nor will Washoe County accept the streets for dedication to Washoe County unless the streets meet those Washoe County standards in effect at the time of offer for dedication.
9. Mandatory solid waste collection.
10. Fence material (if any), height, and location limitations, and re-fencing standards. Replacement fence must be compatible in materials, finish and location of existing fence.

Washoe County Engineering Division – Land Development

2. The following land development conditions are requirements of the Washoe County Engineering Division, which shall be responsible for determining compliance with these conditions.

Contact: Leo Vesely, P.E., 775.328.3600, lvesely@washoecounty.us

- a. Final maps and final construction drawings shall comply with all applicable statutes, ordinances, rules, regulations, and policies in effect at the time of submittal of the tentative map or, if requested by the developer and approved by the applicable agency, those in effect at the time of approval of the final map.
- b. Prior to acceptance of public improvements and release of any financial assurances, the developer shall furnish to the Engineering Division a complete set of reproducible as-built construction drawings in an acceptable digital format prepared by a civil engineer licensed in the State of Nevada.
- c. The developer shall be required to participate in any applicable General Improvement District or Special Assessment District formed by Washoe County. The applicable County Department shall be responsible for determining compliance with this condition.
- d. The developer shall provide written approval from the U.S. Postal Service concerning the installation and type of mail delivery facilities. The system, other than individual mailboxes, must be shown on the project construction plans and installed as part of the onsite improvements.
- e. A complete set of construction improvement drawings, including an onsite grading plan, shall be submitted to the County Engineer for approval prior to finalization of any portion of the tentative map. Grading shall comply with best management practices (BMPs) and shall include detailed plans for grading and drainage on each lot, erosion control (including BMP locations and installation details), slope stabilization and mosquito abatement. Placement or disposal of any excavated material shall be indicated on the grading plan.

- f. All open space shall be identified as common area on the final map. A note on the final map shall indicate that all common areas shall be privately maintained and perpetually funded by the Homeowners Association. The maintenance of the common areas shall also be addressed in the CC&Rs to the satisfaction of the District Attorney's Office.
- g. Any existing easements or utilities that conflict with the development shall be relocated, quitclaimed, and/or abandoned, as appropriate.
- h. Any easement documents recorded for the project shall include an exhibit map that shows the location and limits of the easement in relationship to the project.
- i. All existing overhead utility lines shall be placed underground, except electric transmission lines greater than 100 kilovolts, which can remain above ground.
- j. With each affected final map, provide written approval from NV Energy for any improvements located within their easement or under their facilities.
- k. Appropriate easements shall be granted for any existing or new utilities, with each affected final map. This includes, but is not limited, to electrical lines, water lines, and drainage maintenance access.
- l. A 10 foot Public Utilities Easement and a 10 foot easement for traffic control signage, plowed snow storage and sidewalks shall be granted adjacent to all rights-of-way.
- m. An updated design level geotechnical investigation with fault study shall be provided with the submittal of each final map.
- n. Cut slopes, fill slopes, and berms shall be setback from parcel lines and access easements in accordance with Washoe County Code Article 438.
- o. Prior to recordation of the affected final map, an ASTM E1527-13 Phase I Environmental Site Assessment shall be submitted for all parcels or right-of-way dedicated to Washoe County.
- p. The developer shall obtain a Stormwater Discharge Permit from the Nevada Division of Environmental Protection (NDEP), and a copy of the permit shall be submitted to the County Engineer. The Stormwater Pollution Prevention Plan shall be included with the subdivision improvement drawings.
- q. The Truckee Meadows Regional Stormwater Quality Management Program Construction Permit Submittal Checklists and Inspection Fee shall be submitted with each final map.
- r. A grading bond of \$2,000/acre of disturbed area shall be provided to the Engineering Division prior to approval.

Washoe County Engineering Division – Drainage and Roadway (County Code 110.420)

- s. The conditional approval of this tentative map shall not be construed as final approval of the drainage facilities shown on the tentative map. Final approval of the drainage facilities will occur during the final map review and will be based upon the final hydrology report.
- t. Prior to finalization of the first final map, a master hydrology/hydraulic report and a master storm drainage plan shall be submitted to the County Engineer for approval.
- u. Prior to finalization of any portion of the tentative map, a final, detailed hydrology/hydraulic report for that unit shall be submitted to the County Engineer. All storm drainage improvements necessary to serve the project shall be designed and constructed to County standards and specifications and/or financial assurances in an appropriate form and amount shall be provided.
- v. The 100-year floodplain boundaries and flood elevations shall appear on each final map. If the floodplain boundary has been conditionally changed by a Federal Emergency Management Agency (FEMA) Conditional Letter of Map Amendment or Conditional

Letter of Map Revision, the date of that letter and a note to that effect shall appear on the final map. All grading and construction in these areas shall be in conformance with the Washoe County Code Article 416.

- w. Prior to placement of any fill material or within a FEMA Special Flood Hazard Area, an approved Conditional Letter of Map Revision (CLOMR) shall be obtained from FEMA.
- x. An approved Letter of Map Revision (LOMR) shall be obtained from FEMA prior to issuance of a Certificate of Occupancy for any structures within the Special Flood Hazard Area.
- y. The following note shall be added to each final map; "All properties, regardless if they are located within or outside of a FEMA Special Flood Hazard Area, may be subject to flooding. The property owner is required to maintain all drainage easements and natural drainages and not perform or allow unpermitted and unapproved modifications to the property that may have detrimental impacts to surrounding properties."
- z. Prior to issuance of a grading permit or approval of the affected final map, the developer shall obtain a permit from the COE for any work within the wetlands/waters of the U.S., or a letter from the COE indicating that a permit is not required. A copy of the permit/letter shall be submitted to the County Engineer.
- aa. The final hydrology report shall include an analysis to determine if this project causes an increase in the Wildcreek Detention Dam's peak outflow for both the 100-year 6-hour and 100-year 24-hour storms. Appropriate mitigation shall be provided if this project causes an increase in the Wildcreek Detention Dam's existing peak outflow.
- bb. Notes on the final map and the CC&Rs shall address the following items:
 - a. All lots subject to 100-year flooding shall be identified. All FEMA flood zones, floodways and base flood elevations shall be shown.
 - b. Structures located within the 100-year floodplain must comply with County Code Article 416, Flood Hazards.
 - c. No structures, fencing or fill will be allowed within the FEMA floodway except as provided for in Section 110.416.70.
- cc. Standard reinforced concrete headwalls or other approved alternatives shall be placed on the inlet and outlet of all drainage structures, and grouted rock riprap shall be used to prevent erosion at the inlets and outlets of all culverts.
- dd. The developer shall provide pretreatment for petrochemicals and silt for all storm drainage leaving the site.
- ee. Drainage swales that drain more than two lots are not allowed to flow over the curb into the street; these flows shall be intercepted by an acceptable storm drain inlet and routed into the storm drain system.
- ff. A note on the final map shall indicate that all drainage facilities not maintained by Washoe County shall be privately maintained and perpetually funded by a homeowners association. The maintenance and funding of private drainage facilities shall also be addressed in the CC&Rs to the satisfaction of the District Attorney's Office.
- gg. The maximum permissible flow velocity (that which does not cause scour) shall be determined for all proposed channels and open ditches. The determination shall be based on a geotechnical analysis of the channel soil, proposed channel lining and channel cross section, and it shall be in accordance with acceptable engineering publications/calculations. Appropriate linings shall be provided for all proposed channels and open ditches such that the 100-year flows do not exceed the maximum permissible flow velocity.
- hh. Prior to issuance of a grading permit or finalization of the first final map, a wetlands delineation must be approved by the United States Army Corps of Engineers (COE). A

copy of the wetlands delineation and the COE approval shall be submitted to the County Engineer.

- ii. Prior to issuance of a grading permit or approval of the affected final map, the developer shall obtain a permit from the COE for any work within the wetlands/waters of the U.S., or a letter from the COE indicating that a permit is not required. A copy of the permit/letter shall be submitted to the County Engineer.
- jj. All slopes steeper than 5:1 shall be stabilized to control erosion. The County Engineer shall determine compliance with this condition.
- kk. Maintenance access and drainage easements shall be provided for all existing and proposed drainage facilities. All drainage facilities located within Common Area shall be constructed with an adjoining minimum 12' wide gravel access road. Maintenance access road shall be provided to the bottom of proposed detention basins as well as over County owned and maintained storm drainage facilities.
- ll. Drainage easements shall be provided for all storm runoff that crosses more than one lot.
- mm. A note shall be added to the final map and similar language contained with the project CC&Rs stating that owners of parcels created by a final map within this development shall not protest the formation of a Storm Water Utility District, Flood Control District, Special Assessment District or other funding mechanism which is approved and created for the purpose of storm water and/or flood water management.
- nn. Offsite drainage and common area drainage draining onto residential lots shall be perpetuated around the residential lots and drainage facilities capable of passing a 100-year storm shall be constructed with the subdivision improvements to perpetuate the storm water runoff to improved or natural drainage facilities. The maintenance of these drainage facilities shall be addressed in the CC&Rs to the satisfaction of the District Attorney's Office.

Washoe County Engineering Division – Traffic and Roadway (County Code 110.436)

- 3. The following traffic and roadway conditions are requirements of the Washoe County Engineering Division, which shall be responsible for determining compliance with these conditions.

Contact: Leo Vesely, P.E., 775.328.3600, ivesely@washoecounty.us & Mitchell Fink, 775.328.2050, mfink@washoecounty.us

- a. All roadway improvements necessary to serve the project shall be designed and constructed to County standards and specifications and/or financial assurances in an appropriate form and amount shall be provided.
- b. Provide a copy of the traffic impact report associated with this project, including all addendums and updates for review by the Washoe County Engineering Division.
- c. Street names shall be reviewed and approved by the Regional Street Naming Coordinator.
- d. Proposed landscaping and/or fencing along street rights-of-way and within median islands shall be designed to meet American Association of State Highway and Transportation Officials (AASHTO) sight distances and safety guidelines. No tree shall overhang the curb line of any public street.
- e. Streetlights shall be constructed to Washoe County standards at locations to be determined at the final design stage.
- f. AASHTO clear zones shall be determined for all streets adjacent to retaining walls or slopes steeper than 3:1. If a recoverable or traversable clear zone cannot be provided, an analysis to determine if barriers are warranted shall be submitted for approval.

- g. Sidewalks shall be constructed in accordance with current Washoe County standards for street improvements, and a connection shall be provided from Falcon Ridge North to the Falcon Ridge subdivision.
- h. Appropriate curve warning signs and/or a lower speed limit shall be determined and posted on all horizontal roadway curves that do not meet the standard Washoe County 25-mile per hour design speed.
- i. Appropriate transitions shall be provided between the existing and proposed improvements at all proposed street connections. This may include removal of existing pavement.
- j. Any streetlights that do not meet Washoe County standards shall be placed outside Washoe County right-of-way. These streetlights shall be private, and the CC&Rs shall indicate operation and maintenance of the streetlights shall be the responsibility of the Homeowners Association. The County Engineer and the District Attorney's Office shall determine compliance with this condition.
- k. A 20' setback is required between the back of the sidewalk and the front of the garage.
- l. A traffic analysis for the proposed traffic signal at the existing El Rancho Drive/Falcon Rock Lane intersection shall be provided showing that the traffic volumes associated with this phase of development have been incorporated into the design of this intersection.
- m. Prior to finalization of any portion of the tentative map, a detailed analysis of turning movements for emergency and service vehicles shall be provided to the Engineering Division.
- n. The conditions, covenants and restrictions (CC&Rs) shall prominently note to the satisfaction of the District Attorney's Office and the County Engineer that Washoe County will not assume responsibility for maintenance of the development's private street system or accept the streets for dedication to Washoe County unless the streets meet those Washoe County standards in effect at the time of the offer of dedication.
- o. Adequate snow storage easements shall be identified on the final plat.
- p. Prior to release of any financial assurances for the private improvements, the development shall provide the Engineering Division with a letter prepared by a civil engineer licensed in the State of Nevada, certifying that the private improvements have been constructed in accordance with the approved plans.

Washoe County Engineering Division – Utilities (County Code 422 & Sewer Ordinance)

4. The following utilities conditions are requirements of the Washoe County Engineering Division, which shall be responsible for determining compliance with these conditions.

Contact: Tim Simpson, P.E., 775.954.4648, tsimpson@washocounty.us

- a. The applicant shall conform to all conditions imposed by intergovernmental agreements required to provide sewer service to the subject project, and, if required, be a party to any such agreements.
- b. All fees shall be paid or deferred in accordance with Washoe County Ordinance prior to the approval of each final map.
- c. Improvement plans shall be submitted and approved by CSD prior to approval of the final map. They shall be in compliance with Washoe County Design Standards and be designed by a Professional Engineer licensed to practice in the State of Nevada.
- d. The applicant shall submit an electronic copy of the street and lot layout for each final map at initial submittal time. The files must be in a format acceptable to Washoe County.
- e. The applicant shall construct and/or provide the financial assurance for the construction of any on-site and off-site sanitary sewer collection systems prior to signature on each

final map. The financial assurance must be in a form and amount acceptable to the CSD.

- f. Approved improvement plans shall be used for the construction of on-site and off-site sanitary sewer collection system. The CSD will be responsible to inspect the construction of the sanitary sewer collection system.
- g. The sanitary sewer collection system must be offered for dedication to Washoe County along with the recordation of each final map.
- h. Easements and real property for all sanitary sewer collection systems and appurtenances shall be in accordance with Washoe County Design Standards and offered for dedication to Washoe County along with the recordation of each final map.
- i. A master sanitary sewer report for the entire tentative map shall be prepared and submitted by the applicant's engineer at the time of the initial submittal for the first final map which addresses:
 - a. the estimated sewage flows generated by this project,
 - b. projected sewage flows from potential or existing development within tributary areas,
 - c. the impact on capacity of existing infrastructure,
 - d. slope of pipe, invert elevation and rim elevation for all manholes,
 - e. proposed collection line sizes, on-site and off-site alignment, and half-full velocities.
- j. No Certificate of Occupancy will be issued until all the sewer collection facilities necessary to serve each final map have been completed, accepted and engineer prepared as-built drawings are delivered to the utility. As-built drawings must be in a format acceptable to Washoe County.
- k. No permanent structures (including rockery or retaining walls, buildings, etc.) shall be allowed within or upon any County maintained utility easement.
- l. A minimum 30-foot sanitary sewer and access easement shall be dedicated to Washoe County over any facilities not located in a dedicated right of way.
- m. A minimum 12-foot wide all weather sanitary sewer access road shall be constructed to facilitate access to off-site sanitary sewer manholes.

Washoe County Planning and Building Division – Park Planning

- 5. The following conditions are requirements of Park Planning which shall be responsible for determining compliance with these conditions.

Contact: Sophia Kirschenman, 775.328.3623, skirschenman@washoecounty.us

- a. Prior to recordation of the final map, the applicant shall record an irrevocable offer of dedication for a 20' wide, non-motorized public trail easement along the eastern boundary of the subject site (APN 035-721-02). The easement area shall be depicted on the final map. The detention pond, walls, and any other structures will not be located within the trail easement area.

Washoe County Planning and Building Division – Water Planning

- 6. The following conditions are requirements of Water Planning which shall be responsible for determining compliance with these conditions.

Contact: Vahid Behmaram, 775.954.4647, vbehmaram@washoecounty.us

- a. There are no water rights conditions for approval of this tentative map.
- b. Following the possible approval of the tentative subdivision map, the potential future project will require water supply and sewer service which in turn will require the

expansion of water and sewer services and annexation to TMWA service area, if not already annexed.

- c. Valid water and sewer will serve letters will be required prior to approval of the final map proposed by this tentative map.

*** End of Conditions ***



WASHOE COUNTY

COMMUNITY SERVICES DEPARTMENT

Engineering and Capital Projects

1001 EAST 9TH STREET
 RENO, NEVADA 89512
 PHONE (775) 328-3600
 FAX (775) 328.3699

Date: September 17, 2019

To: Julee Olander, Planner

From: Leo Vesely, P.E., Licensed Engineer
 Kristine R. Klein, P.E., Sr. Licensed Engineer

Re: Special Use Permit Case **WSUP19-0018 – Foothills Storage Grading**
 APN 017-051-04

GENERAL PROJECT DISCUSSION

Washoe County Engineering staff has reviewed the above referenced application. The Special Use Permit is for minor grading and to allow the business to store operable vehicles on-site. The Engineering and Capital Projects Division recommends approval with the following comments and conditions of approval which supplement applicable County Code and are based upon our review of the site and the application prepared by Mark Hain. The County Engineer shall determine compliance with the following conditions of approval.

For questions related to sections below, please see the contact name provided.

GENERAL CONDITIONS

Contact Information: Leo Vesely, P.E. (775) 328-3600

1. A complete set of construction improvement drawings, including an on-site grading plan, shall be submitted when applying for a building/grading permit. Grading shall comply with best management practices (BMPs) and shall include detailed plans for grading, site drainage, erosion control (including BMP locations and installation details), slope stabilization, and mosquito abatement. Placement or removal of any excavated materials shall be indicated on the grading plan. Silts shall be controlled on-site and not allowed onto adjacent property.
2. All grading shall be in accordance with Article 110.438 Grading Standards.
3. All disturbed areas left undeveloped for more than 30 days shall be treated with a dust palliative. Disturbed areas left undeveloped for more than 45 days shall be revegetated. Specifications for revegetation procedure and seed mix shall be prepared by a licensed landscape architect.
4. If any, plans shall clearly show any work to be done in NDOT right-of-way and an occupancy permit shall be obtained and a copy submitted to Washoe County prior to approval of any grading/building permit.
5. Provide documentation confirming that both legal access and the right to maintain/improve King Lane have been granted to the site.



INTEGRITY



EFFECTIVE COMMUNICATION



QUALITY PUBLIC SERVICE

Subject: **WSUP19-0018 – Foothill Storage Grading**
Date: August 30, 2019
Page: 2

DRAINAGE (COUNTY CODE 110.416, 110.420, and 110.421)

Contact Information: Leo Vesely, P.E. (775) 328-3600

1. Submit a drainage report in accordance with Article 420 Storm Drainage Standards for all improvements. Pre-development conditions in the drainage report shall be based vegetation coverage that existed prior to clearing the rear portion of the property, and all offsite flows shall be addressed.
2. Any increase in stormwater runoff flow rate resulting from the development of the entire vehicle storage facility (APNs 017-051-04 & -05) and based on the 5 year and 100 storm(s) shall be analyzed for downstream impacts to the point the flows enter Bailey Canyon Creek. Any impacts due to the increased flows shall be mitigated.
3. The following note shall be added to the construction improvement drawings; "All properties, regardless if they are located within or outside of a FEMA Special Flood Hazard Area, may be subject to flooding. The property owner is required to maintain all drainage easements and natural drainages and not perform or allow unpermitted and unapproved modifications to the property that may have detrimental impacts to surrounding properties."
4. The developer shall provide pretreatment for petrochemicals and silt for all storm drainage leaving the site.

TRAFFIC AND ROADWAY (COUNTY CODE 110.436)

Contact Information: Mitchell Fink (775) 328-2050

1. Provide a copy of the Special Use Permit Application to NDOT for their review and comments if this has not been done already.
2. Prior to using King Lane as access to the site, improve King Lane, between the site access and Kivett Lane, to minimum public or private street standards in accordance with Article 110. 436 Street Design Standards. If King Lane remains a private street, the construction improvement drawings shall be included in the building/grading permit application. If King Lane is to be offered for dedication to Washoe County and constructed to County standards; the King Lane construction improvement drawings shall be submitted to the Engineering and Capital Projects Division through the Construction Plan Review application and process, and shall be approved prior to issuance of the building/grading permit.
3. Provide a reciprocal access easement for the access connecting APNs (APNs 017-051-04 & -05).

From: [Oujevolk, Richard](#)
To: [Olander, Julee](#)
Subject: RE: WSUP19-0018
Date: Tuesday, September 10, 2019 10:02:19 AM
Attachments: [image001.png](#)
[image002.png](#)
[image003.png](#)
[image004.png](#)
[image005.png](#)

[**NOTICE:** This message originated outside of Washoe County -- **DO NOT CLICK** on **links** or open **attachments** unless you are sure the content is safe.]

You are welcome. As discussed also add”

Applicant shall contact NDOT District II Traffic Engineering Supv. OR Engineering Services Manager on permit requirements. Permits maybe for any change in existing land use conditions, will need to submit a traffic impact study or letter and our subject to modify existing driveways to current NDOT Standards, Specifications and Guidelines.

Thanks!
OJ

From: Olander, Julee <JOlander@washoecounty.us>
Sent: Tuesday, September 10, 2019 8:36 AM
To: Oujevolk, Richard <ROujevolk@dot.nv.gov>
Subject: RE: WSUP19-0018

Thank you – I’m going to add that as a condition that King lane is for emergency access only then.
Thanks!



Julee Olander

Planner | Community Services Department- Planning & Building Division

jolander@washoecounty.us | Office: 775.328.3627 | Fax: 775.328.6133

1001 E. Ninth St., Bldg A., Reno, NV 89512



Connect with us: [cMail](#) | [Twitter](#) | [Facebook](#) | www.washoecounty.us

From: Oujevolk, Richard [<mailto:ROujevolk@dot.nv.gov>]
Sent: Tuesday, September 10, 2019 8:34 AM
To: Olander, Julee
Cc: D2 Traffic DL; District II Permits DL
Subject: RE: WSUP19-0018

[**NOTICE:** This message originated outside of Washoe County -- **DO NOT CLICK** on **links** or open **attachments** unless you are sure the content is safe.]

Hi Julee – sorry, I’ve been really behind on development reviews. Due to lot sizing, NDOT would not be opposed to entering and exiting from Geiger Grade for this development we just approved a traffic study for a mini storage just east of here with the same problem. The access’ are “non-conforming” but what can you do when you have platted 100’ lots fronting the road 😞.

OJ

From: Olander, Julee <JOlander@washoecounty.us>
Sent: Monday, September 09, 2019 2:16 PM
To: Oujevolk, Richard <ROujevolk@dot.nv.gov>
Subject: WSUP19-0018

OJ,

I have attached the application for the RV storage at 1525 Geiger Grade that I left a message about. The property owner now owns APN: 017-05104 & 05. Could you let me know if the traffic could enter and exit from Geiger Grade instead of King Lane, which is an unimproved easement. Thought that they enter through one parcel and the exit thru another and use the existing driveways. If you could please let me know by the end of the week that would be great.

Thanks,



Julee Olander

Planner | Community Services Department- Planning & Building Division

jolander@washoecounty.us | Office: 775.328.3627 | Fax: 775.328.6133

1001 E. Ninth St., Bldg A., Reno, NV 89512



Connect with us: [cMail](mailto:) | [Twitter](https://twitter.com/) | [Facebook](https://www.facebook.com/) | www.washoecounty.us

From: [Gil, Donald](#)
To: [Olander, Julee](#)
Subject: FW: August Agency Review Memo IV
Date: Thursday, August 22, 2019 3:18:36 PM
Attachments: [August Agency Review Memo IV.pdf](#)
[image001.png](#)
[image002.png](#)
[image003.png](#)
[image004.png](#)
[image005.png](#)
[image006.gif](#)
Importance: High

Julee,

The Washoe County Sheriff's Office Patrol Division has no issues with item #5. It was difficult for me to ascertain where our impact would come into play and I was trying to find information related to traffic issues, etc.? If I am missing something can you please advise? Otherwise I am not seeing any issues on our end.

Thank you,

Don

Don Gil

Captain – Patrol Division

911 Parr Blvd. Reno, NV 89512

Desk: 775-328-3354

Email: dgil@washoecounty.us

Web: www.WashoeSheriff.com

From: Fagan, Donna
Sent: Wednesday, August 21, 2019 3:46 PM
To: Gil, Donald <DGil@washoecounty.us>
Subject: August Agency Review Memo IV

Captain Gil,

Please find the attached Agency Review Memo with a case received this month by CSD, Planning and Building.

You've been asked to review items #3, #4, #5, and #6. Click on the highlighted item descriptions for a link to the application.

Please send any comments or conditions to the planner for that item.

Thank you,
Donna



Donna Fagan

Planning and Building Division | Community Services Department

dfagan@washoecounty.us | Office: 775.328.3616

1001 E. 9th Street, Reno, NV 89521





Washoe-Storey Conservation District

Bret Tyler Chairmen
Jim Shaffer Treasurer
Cathy Canfield Storey app
Jean Herman Washoe app

1365 Corporate Blvd.
Reno NV 89502
775 857-8500 ext. 131
nevadaconservation.com

September 04, 2019

Washoe County Community Services Department

C/O Julee Olander, Planner

1001 E Ninth Street, Bldg A

Reno, NV 89512

R: WADMIN19-0018 FootHill Storage

Dear Julee,

In reviewing the special use permit to store operable vehicles, the Conservation District has no comments.

Thank you for providing us the opportunity to review the project that may have impacts on our natural resources.

Sincerely,

Tyler-Shaffer

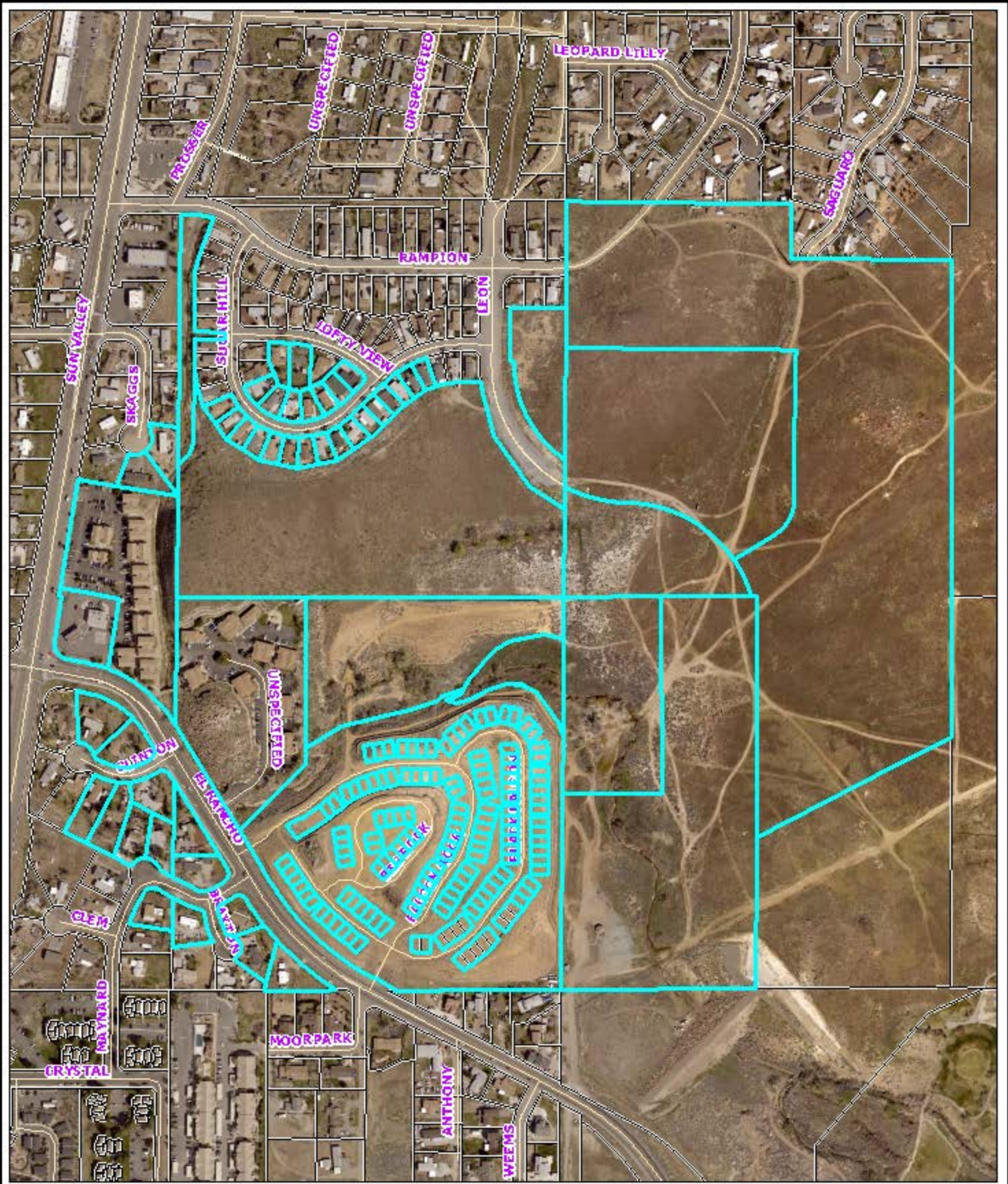

WTM19-004 Falcon Ridge North
 Noticing Map- 700 feet

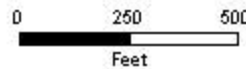

Community Services
 Department

WASHOE COUNTY
 NEVADA

1001 E. Winn St.
 Reno, Nevada 89512 (775) 328-3600

Source: Planning and Building Division

Date: 08/20/2019

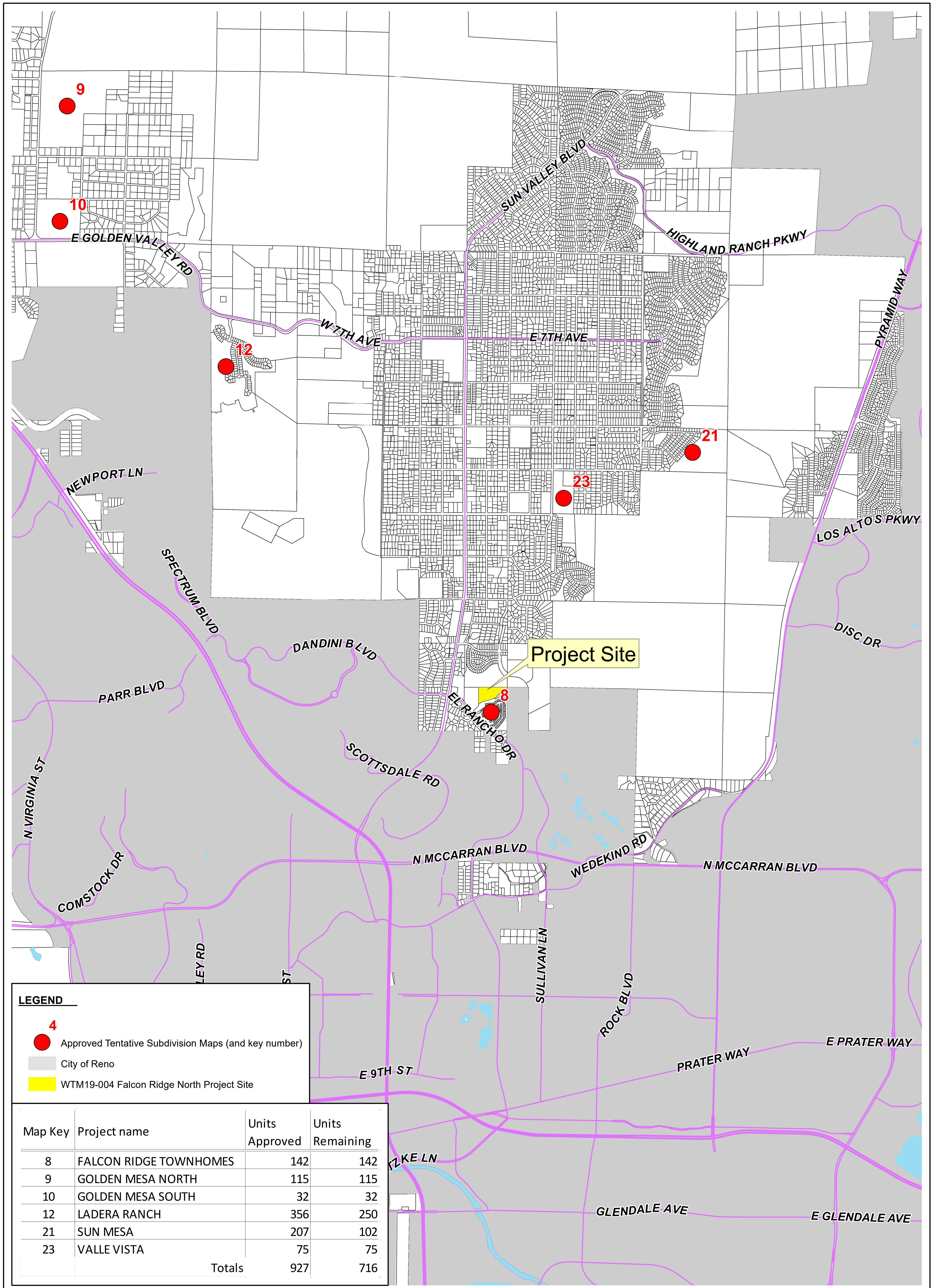

LEGEND

- 4 Approved Tentative Subdivision Maps (and key number)
- City of Reno
- WTM19-004 Falcon Ridge North Project Site

Map Key	Project name	Units Approved	Units Remaining
8	FALCON RIDGE TOWNHOMES	142	142
9	GOLDEN MESA NORTH	115	115
10	GOLDEN MESA SOUTH	32	32
12	LADERA RANCH	356	250
21	SUN MESA	207	102
23	VALLE VISTA	75	75
Totals		927	716

**Planning and Building
Community Services Department**

G:\arcdata\projects\approve_unb\NV_App_unb\unb_April2018.mxd

**Approved Residential Subdivisions
SUN VALLEY VICINITY
(Unincorporated Area Only)**

SOURCE: Community Services Department, Planning and Building Division

**WASHOE COUNTY
NEVADA**

Post Office Box 11130
Reno, Nevada 89520

April, 2018
(775) 328-3600

Appendix B – Falcon Ridge Specific Plan

Contents

	Page
Statement of Plan and Purpose	B-3
Project Location	B-3
Goals	B-4
Land Use Compatibility	B-4
Policies to Implement Specific Goals	B-5
Development Standards	B-5
Utilities	B-5
Trails	B-5
Structure Design	B-6
Grading	B-7
Building Siting	B-7
Recreational Amenities	B-8
Landscaping	B-8
Open Space/Buffers	B-8
Traffic Access	B-8
Parking	B-9
Fencing	B-9
Air Quality	B-9
Archeological	B-9
Wild Life and Fisheries Preservation	B-9
Fire Protection	B-9
Natural Hazards	B-10
Implementation	B-10
 List of Figures	
Figure B-1: Location Map	B-3
Figure B-2: Conceptual Site Plan	B-4
Figure B-3: Trail Location	B-5
Figure B-4: Club House Architecture	B-6
Figure B-5: Typical Building Elevation 1	B-7
Figure B-6: Typical Building Elevation 2	B-7

This page intentionally left blank.

Goals

The Falcon Ridge Specific Plan is designed to create a medium-density residential community with a maximum of 269 dwelling units. The plan is sensitive to the unique environmental characteristics of the property and, as such, fosters a stewardship with the natural setting, by establishing the following goals:

1. Provide phasing of the project in one or more phases.
2. Guarantee compatibility with adjacent existing developments by utilizing landscaped buffer areas, building height restrictions, curtailing of light pollution, and a maximum density of 269 dwelling units.
3. Protect and enhance the drainage that separates the northern and southern half of the project.
4. Provide a trail composed of decomposed granite (DG) that will connect to a City of Sparks public park.

Land Use Compatibility

The Falcon Ridge Specific Plan allows a maximum of 269 lots with the average lot size of 1,285 square feet generally following the layout depicted in Figure B-2. The overall density will not exceed ± 10.6 dwelling units per acre.

Figure B-2: Conceptual Site Plan



Policies to Implement the Specific Plan Goals

1. The pedestrian trail shall be constructed prior to the recordation of the first final map or shall be financially guaranteed as part of the subdivision improvement agreement and completed prior to the issuance of a certificate of occupancy for a residential dwelling unit.
2. Landscape buffers at a minimum of 60 feet from the single family residences to the south, 50 feet from the west, and 45 feet from the north and east.
3. Establishment of an Open Space and drainage easement prior to recordation of final map.
4. Building heights will be limited to 35 feet and be consistent with the two-story height restriction in the Sun Valley Area Plan Modifiers.
5. All other goals will be upheld through the implementation and approval of the Specific Plan. The developer agrees to meet all of these goals without exception.

Development Standards

Utilities

The property included in the Falcon Ridge Specific Plan will be developed with a community water and sewer system. All utilities necessary to service the property are to be funded by Falcon Ridge and turned over to Washoe County when the project is completed. Goals of the utility plan include:

1. Preserve views and landform by placing utilities underground.
2. Screening home owners utilities from the public view.
3. Screening by use of rocks and large boulders and natural berms.

Trails

The Falcon Ridge Specific Plan provides for a pedestrian and equestrian trail as identified in Figure B-3.

Figure B-3: Trail Location



The goals of the trail plan include:

1. Connection to a City of Sparks public park to the east.
2. Contour the trail with in the natural features.
3. The trail will be constructed with decomposed granite.
4. Maintenance of the trail will be by the Home Owners Association.

Structural Design

Structural guidelines are designed such that they assure any residential structures contained on the property are abided. Please see Figures B-4, B-5, and B-6 for a depiction of the architecture. The goals of the structural design plan include:

1. Utilize materials that require minimum maintenance.
2. Reflect the regional flavor of the area by the use of wood, stone, stucco or a combination of all three.
3. Utilize material palettes and colors that enhance the natural environment.
4. Follow the Nevada Revised Statues for Energy Conservation.

Figure B-4: Club House Architecture

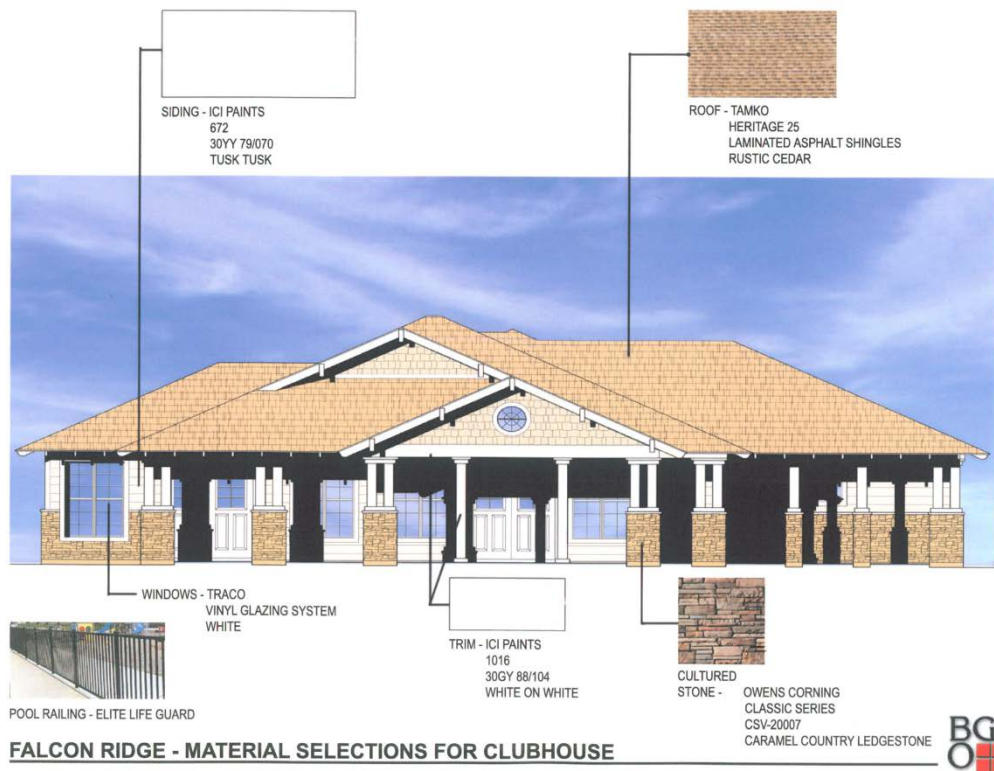

Figure B-5: Typical Building Elevation 1**Figure B-6: Typical Building Elevation 2****Grading**

The grading considerations defined in Falcon Ridge Specific Plan will grade as little as possible and will follow the contours of the earth reshaping as needed. Moreover, the entire property has already been graded with the last approved development and the new design will take advantage of the existing grading that has already occurred. Any new grading will follow these goals which include:

1. Minimize disruption to natural topography.
2. Utilization of natural contours and slopes
3. Complement the natural characteristics of the landscape.
4. Limit grading in the drainage way to the design of the boxed culvert.
5. Limit fill in the drainage way to the design of the boxed culvert.
6. Use of rockery walls and benching.
7. Preserve natural rock outcroppings.
8. Use erosion control by slope stabilization runoff controls, collection features and Best Management Practices (BMP).

Building Siting

The primary building siting considerations defined in Falcon Ridge Specific can be seen in the Conceptual Site Plan (Figure B-2). The goals of the building siting use plan include:

1. Site structures clear of all earthquake faults.
2. Introduce indigenous trees for additional shade.
3. Slope driveways gradually for safety.

Recreational Amenities

Falcon Ridge will be constructing a Club House and Pool for use by the residents and their guests. The club house will include a fitness center, a great room with lounge area and big screen television, kitchen, and a front and back patio.

Landscaping

The landscaping and zoning concepts are required by the Falcon Ridge Specific Plan to bring harmony to the existing terrain. We are including all the conditions from the Design Review Committee of the original approved project as well some additional features that will enhance the project. Revegetation will occur in areas deemed necessary by the Design Review Committee.

1. A minimum of 43 evergreen trees ranging from 4 feet to 10 feet will be added to the southern buffer.
2. A minimum of 10 deciduous trees will be added to the southern buffer.
3. A minimum of 50, five gallon shrubs will be added to the southern buffer.
4. Drought tolerant plant species will be used throughout the project.
5. A significant amount of evergreen trees, deciduous trees, and five gallon shrubs will be used throughout the entire site and around the perimeter of the project.
6. Trees shall be placed as erosion control with irrigation in common areas.
7. Adequate trees shall be planted to buffer the area of the eastern edge of the project bordering the City of Sparks.
8. Crushed grey rock used as rock mulch will be used as decorative rock.
9. Significant ground cover with trees and shrubs.
10. Inert materials may be used as ground cover not to exceed 50 percent of total ground cover.
11. Rock on rockery walls shall not be light colored, but shall blend with the surrounding terrain.

Open Space/Buffers

All open space and buffers shall be included and defined in the Falcon Ridge Specific Plan. The goals of the open space/buffer plan include:

1. Determined limits and open space areas at the time of the tentative map.
2. Effectively screen the project with rockery walls and landscaping on all sides with the exception of a small section on the northwest portion of the property located in the FEMA flood zone.
3. Incorporate buffers along the edge of property as depicted in Figure B-2.
4. Use minimum buffer widths of 45 to 60 feet.

Traffic and Access

Traffic and access considerations as defined in the Falcon Ridge Specific Plan are designed to aid, protect the community, and protect the investment of individual property owners as well as surrounding developments. Emergency access connections are shown in Figure B-3. The goals of the traffic and access plan include:

1. Access to Falcon Ridge will occur from El Rancho Drive.
2. El Rancho Drive is designated as an arterial in the Regional Transportation Commission (RTC) road system.
3. A traffic signal will be placed at the entrance to Falcon Ridge prior to the construction or recordation of the 143rd dwelling unit to mitigate traffic concerns in this area.

4. The developer agrees to pay up to 100 percent of the total cost of the signal.
5. Prior to the installation of the traffic signal, a left out approach will be prohibited on El Rancho Drive from the southern most exit out of the development. Left in, right in, and right out will be allowed.
6. Widening of El Rancho Drive will occur to create a sidewalk, bike lane, and a center lane.
7. An RTC bus stop and pad will be placed on El Rancho Drive next to Falcon Ridge.
8. Complete re-stripping and signing will occur along the modified sections of El Rancho Drive.

Parking

The parking provided at Falcon Ridge will be abundant:

1. Every townhome will have a minimum of four spaces, two from a garage and two in front of the residence.
2. Every condominium will have at least three spaces, two from a garage and one in front of the residences.
3. The Club House will have seven parking spaces.
4. Guest parking will exceed 70 spaces throughout the development.

Fencing

The goals of the fencing plan include:

1. Maintain a natural open image.
2. Prohibit solid perimeter fences; rockery walls will be used on the perimeter of the site.
3. Maximize views without fences.

Air Quality

Air quality is important in the Falcon Ridge Specific Plan. The goals of the air quality plan include:

1. Maintain dust control during construction.
2. Prohibit wood burning stoves as per Washoe County Code.

Archeological

There are no historic buildings or landmarks on this site.

Wildlife and Fisheries Preservation

There are no wildlife habitats or fisheries existing in the development.

Fire Protection

Falcon Ridge will be designed to implement the latest advances in fire safety and management. The characteristic of the development does not lend itself to any unusual fire protection problems. An Emergency Vehicle Access Road (see Figure B-2) will be constructed on the west side of the property to ensure the highest level of safety achievable.

Natural Hazards

The project site is separated north from south by a FEMA flood zone. This flood zone will remain natural open space and does not pose any risk to the development.

Implementation

The standards included in the Falcon Ridge Specific Plan shall be implemented through tentative map conditions, improvements plans, CC&Rs, or deed restrictions as appropriate. Washoe County staff shall determine implementation measures prior to recordation of any final map. A Design Review Committee will be established by Project CC&Rs, which will review various project design elements such as homes, landscape, fencing requests, etc.

FALCON RIDGE NORTH TENTATIVE MAP



Prepared by:



August 15, 2019

FALCON RIDGE TENTATIVE MAP

Prepared for:

Desert Winds Homes
550 California Avenue
Reno, NV 89509

Prepared by:

Rubicon Design Group, LLC
1610 Montclair Avenue, Suite B
Reno, Nevada 89509
(775) 425-4800

August 15, 2019

Table of Contents

Introduction1
Project Location1
Existing Conditions.....2
Previous Entitlements and Land Use Designations3
Request Summary5
Common Open Space Development9
Potential Impacts14
Planning Policy Analysis15
Tentative Map Findings17

List of Figures:

Figure 1 – Vicinity Map1
Figure 2– Existing Conditions2
Figure 3 – Master Plan Designation3
Figure 4 – Zoning.....4
Figure 5 – Preliminary Site Plan6
Figure 6 – Preliminary Building Elevations8

Appendix and Accompanying Documents

- TM Application Form and Checklists
- Owner Affidavit
- Proof of Property Tax Payment
- TMWA Intent to Serve Letter
- 24x36 Color Landscape Plan
- 24x36 Engineering Plans
- 24x36 Architectural Elevations
- 8.5x11 Copies of Above Exhibits
- Sanitary Sewer Report
- Hydrology Report
- Geotechnical Report

FALCON RIDGE NORTH TENTATIVE MAP

Introduction

This application includes the following request:

- A **Tentative Subdivision Map** to create 52 single family lots, with common open space, on 6.19± acres within the Sun Valley Area Plan.

Project Location

The Falcon Ridge North site (APN 035-721-02) consists of 6.19± acres and is located near the south end of the Sun Valley Area Plan. Specifically, the property is located on the north side of El Rancho Drive and east of Sun Valley Blvd. Figure 1 (below) depicts the project location.



Figure 1 – Vicinity Map

Existing Conditions

Currently, the project site is vacant. Surrounding land uses are: open space to the north and east, single family housing to the south, and apartments to the west.

Property to the south is the Falcon Ridge subdivision, currently under construction. This new project is a continuation of the Falcon Ridge subdivision and was planned and approved as part of the Falcon Ridge Specific Plan.

The property contains moderate slopes, rising from south to north. Portions of the site have been informally graded in the past and have been used for dirt storage from other projects. These disturbed areas will be properly engineered and landscaped with this new project.

The property is accessed from the Falcon Ridge project. Figure 2 shows the existing onsite conditions.



View of property looking north from Falcon Ridge subdivision

Figure 2 – Existing Conditions

FALCON RIDGE NORTH TENTATIVE MAP

Previous Entitlements and Land Use Designations

Falcon Ridge North is located within the Sun Valley Area Plan and is included in the Falcon Ridge Specific Plan. This Specific Plan identifies the site as intended for single family and/or multi family development. This project is a continuation of this approved Specific Plan.

The overall Falcon Ridge Specific Plan area has received approvals for previous tentative maps and final maps. The majority of the area is currently under construction in conformance with these maps. These previous approvals included grading of the Falcon Ridge North parcel. The bulk of the site is graded flat and retaining walls have been installed. This project will continue this previously approved grading in accordance with the existing Conditions of Approval.

The site has a Master Plan designation of Urban Residential (UR) and is zoned Low Density Urban (LDU) across the entire Specific Plan. Per the Washoe County Master Plan (LUTE, p. 50), the LDU zone conforms to the UR designation. Figures 3 and 4 show the designations for the site.

Note that no amendment to the Master Plan or zoning is being requested with this application.



Figure 3 – Master Plan Designation

FALCON RIDGE NORTH TENTATIVE MAP

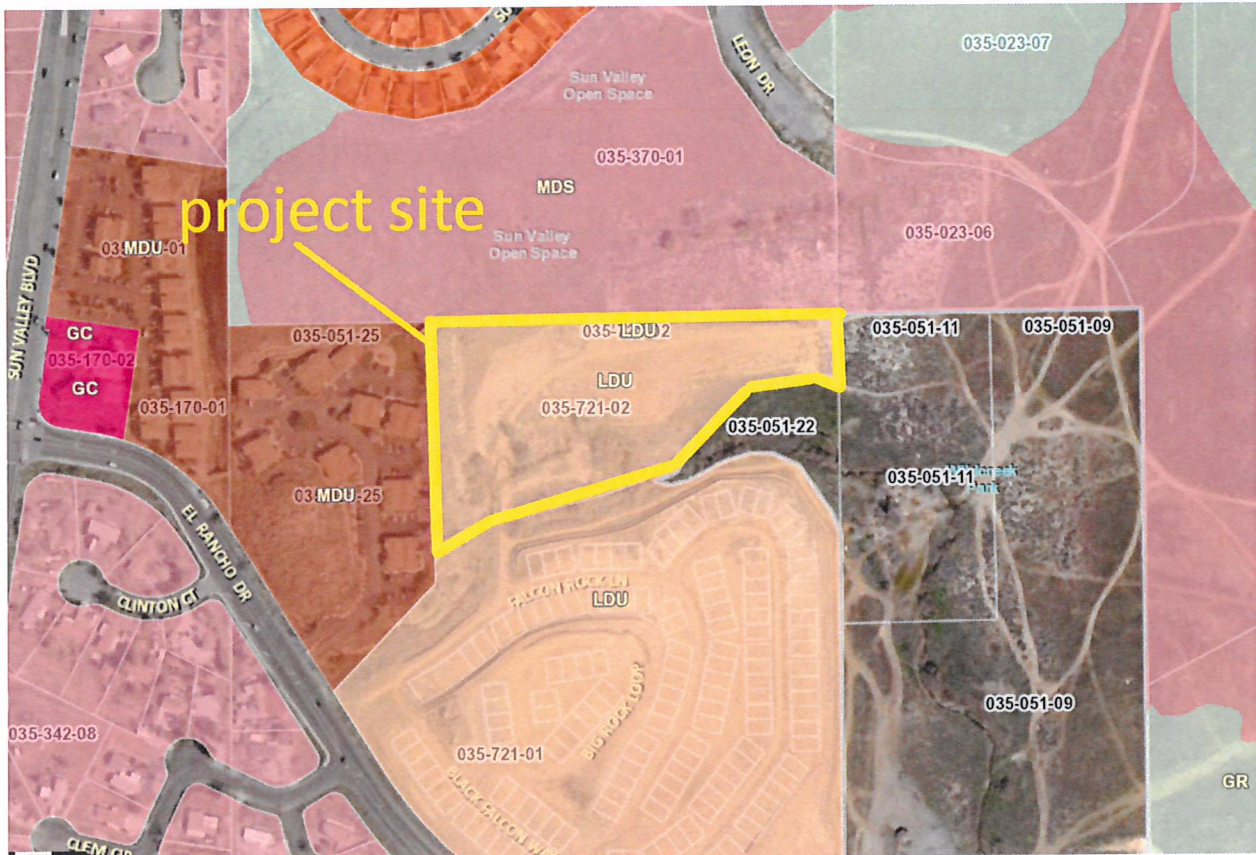

Figure 4 – Zoning

Section 110.106.15 Regulatory Zones, of the Washoe County Development Code identifies the maximum density of the Low Density Urban zone as: *ten (10) units per one (1) acre for single-family; fourteen (14) units per one (1) acre for multi-family; and twelve (12) units per one (1) acre for mobile home parks.*

Given the project area of 6.19 acres, the maximum allowed buildout would be 61 units. The project proposes 52 units and is therefore within the allowed density.

The zoning of the project site is the same as on the rest of the Falcon Ridge Specific Plan area. This project proposes development that is consistent with the earlier approvals both in density and in appearance. The proposed project is therefore directly compatible with the Master Plan, the zoning, and with the Specific Plan.

Request Summary

This application includes a Tentative Subdivision Map request to create 52 attached single family lots at the project site. It is planned to develop Falcon Ridge North utilizing a Common Open Space Development approach, per the standards contained in Article 408 of the Washoe County Development Code.

The plan developed for Falcon Ridge North includes 52 lots for an overall density of 8.4 units per acre. Included within the project are 4.69± acres of common area. This common area includes roads, walkways, and open space. This generous open space area allows the steeper sections of the site to remain undisturbed. This is primarily seen in the northwest corner of the property where no development or grading is proposed.

This common area also allows for safe, convenient street dimensions. For the main roadway within Falcon Ridge North (Street 1 on plans), there will be sidewalks on both sides. For the shorter Street 2, sidewalk is only planned for the north side as there are no houses on the south side of this street.

The project is too small to contribute to regional recreational amenities but it will be possible for residents to access area open space at the northeast corner of the site. Informal walking paths extend offsite toward Wildcreek Park from the project.

Falcon Ridge North will contain two housing footprints. Lots 1-22 have a footprint of 960 square feet. Lots 23-52 are 1,477 square feet. Lots 1-22, along the northern and western property edge, will be graded into the hill to allow for appropriate driveway grades and finish floor elevations. Lots 23-52 will be located on areas that are substantially graded already and minimal additional grading is required for these units.

Lot sizes within Falcon Ridge North are consistent with the LDU zoning and are complementary to the existing Falcon Ridge subdivision to the south. The project is also compatible with the existing multi-family development to the west. The table below provides project data. Figure 5 (following page) shows the proposed site plan.

Item	Units
Housing	52 lots
Lot Area	1.50 acres
Common Area	4.69 acres
Project Size	6.19 acres
Smallest House Lot	960 square feet
Largest House Lot	1,477 square feet
Average Lot Size	1,258 square feet

FALCON RIDGE NORTH TENTATIVE MAP

As seen in Figure 5, the project matches the development pattern of the rest of Falcon Ridge to the south. A homeowners association (HOA) will be created for Falcon Ridge North with the approval of the first final map. The HOA will be responsible for maintaining the open space and common areas and for enforcement of planned covenants, conditions, and restrictions (CC&R's). CC&R's will be developed for the site to ensure that homeowners maintain their properties and that the community vision is carried forward. The HOA may choose to form its own architectural review committee in order to further regulate any proposed modifications to homes (i.e. additions, patio covers, detached garages, etc.). Of course, any modification to the approved home plans would require compliance with the Falcon Ridge Specific Plan zoning standards (i.e. setbacks, etc.) and would be subject to review and approval by Washoe County. The CC&R's are not enforced by the County but will provide the HOA with a mechanism to enforce the community standards and vision. The CC&R's will be provided to new home buyers at the time of purchase and will be recorded against new lots within Falcon Ridge North.

Primary access will be provided through the Falcon Ridge project, which in turn connects to El Rancho Drive at the El Rancho/Falcon Rock Lane intersection. Falcon Rock Lane loops through Falcon Ridge and provides an emergency access driveway onto El Rancho Drive at its western end. This secondary access is to include an emergency access gate at this western end, between Falcon Ridge and El Rancho Drive.

A traffic light is also planned for the existing El Rancho/Falcon Rock Lane intersection. This light will enhance safety for residents entering and existing the project area and for pedestrians crossing El Rancho Drive. Installation of this light is expected in the near future.

Roadways within Falcon Ridge North will be private and will match the already installed streets within Falcon Ridge. There are two street sections proposed. As shown on the attached plans, Street 1 includes a 4' sidewalk on each side of 26'-wide paved travel lanes. Street 2 is similar but with sidewalk on only one side. As there are no houses planned for the south side of Street 2, no sidewalk is needed there.

Complete buildout of the project will be somewhat dependent on market conditions but the developer intends to start as soon as possible. The project is planned to be built as a single phase. A final map will follow this tentative map process and bonding for improvements shall occur in accordance with Washoe County requirements and policies.

Home plans for Falcon Ridge North are still being developed but will be comparable to the existing units within Falcon Ridge. Consistent with Washoe County policy, final home plans and elevations will be subject to review for compliance with the Falcon Ridge Specific Plan. Figure 6 shows preliminary elevation concepts.

The overall Falcon Ridge project includes a gate at the main entrance on El Rancho Drive. This gate was designed as part of previous tentative maps for the area but will serve this project as well.

Fencing for the project will include six-foot wood fences for side and rear yards. These fencing requirements will also be included in the CC&R's recorded for Falcon Ridge North.

FALCON RIDGE NORTH TENTATIVE MAP



Figure 6 – Preliminary Building Elevations

Common Open Space Development

Article 408 of the Washoe County Development Code establishes regulations related to Common Open Space Developments (COSD). This complete code section is included below, with responses in **bold face** type.

Section 110.408.00 Purpose. The purpose of this article, Article 408, Common Open Space Development, is to set forth regulations to permit variation of lot size, including density transfer subdivisions, in order to preserve or provide open space, protect natural and scenic resources, achieve a more efficient use of land, minimize road building, and encourage a sense of community.

The project conforms to this purpose by minimizing lot area in favor of open space and reduced grading.

Section 110.408.05 Applicability. Common open space development may be allowed in any residential land use category or any general, office or tourist commercial regulatory zone.

No response required.

Section 110.408.10 Applications. If the provisions of this article are utilized, the application for a tentative subdivision map or a parcel map, as provided in Division Six, shall state that a common open space development is proposed.

The application request states this and the common open space regulations are addressed in the report.

Section 110.408.15 Non-Residential Uses. Non-residential uses that serve the residents of a common open space development may be allowed provided they are allowed by, and meet the requirements of, Article 302, Allowed Uses, and are designed to be an integral part of the project.

There are no non-residential uses in this request.

Section 110.408.20 Density and Intensity.

(a) Residential. The total number of dwelling units in the proposed common open space development shall not exceed the total number of dwelling units allowed by the underlying regulatory zones(s). The gross site area may include more than one (1) parcel. (b) Non-Residential. The total amount of non-residential space shall not exceed the amount of space allowed by Article 106, Regulatory Zones, or Article 402,

Density of the proposed project conforms to the underlying zone. The LDU zone allows for a maximum of 10 units per acre for single family. This tentative map proposes a gross density of 8.4 units per acre.

Density/Intensity Standards. The amount of non-residential space may be further restricted if the Planning Commission finds that such restriction is necessary to preserve the primary residential character of the development.

There are no non-residential uses in this request.

(c) General. All development shall comply with the height standards in Table 110.406.05.1, Standards.

The project conforms to this height limit of 35' for the LDU zone.

Section 110.408.25 Lot and Yard Standards. The complete common open space development must comply with the minimum lot width, front yard setbacks, side yard setbacks, and rear yard setbacks in Table 110.406.05.1, Standards, or as an alternative, typical building envelopes shall be shown on the tentative subdivision map or parcel map where these standards are proposed to be varied below the minimum standard.

The project is consistent with previously approved tentative maps for Falcon Ridge. The lot design is not standard County Code in that front yard areas are excluded from the individual lots. However, this design is consistent with the Falcon Ridge Specific Plan which is the governing document for the site. This design is also consistent with the previously approved sections of Falcon Ridge.

Section 110.408.30 Site Analysis to Determine Common Open Space and Lot Size Variations. A site analysis showing development opportunities and constraints shall be prepared as a key consideration, along with the project design objectives, to determine the total area covered by lots and roads, lot areas, and the total area to be designated as common open space. The site analysis shall include information and maps, including a site opportunities and constraints map, describing all significant physical and contextual features or factors which may affect the development of the property. The elements of the site analysis shall include, as a minimum, the following information:

(a) Location Map. A general location map providing the context of location and vicinity of the site.

Figure 1 (page 1) included in this report provides an overall location/vicinity map for Falcon Ridge North. Additionally, a vicinity map is also included on the Tentative Map Title Sheet in the attached map pocket.

(b) Land Use. Current and planned land use on the site and adjacent current, planned and approved, but unbuilt land uses.

As depicted in this report, the project site is currently vacant but has been graded in the past. The site is part of the Falcon Ridge Specific Plan and is zoned LDU. No changes to this zoning are included in this request. Property to the north is developed as single family homes with common open space, similar to what is proposed here. To the east is public open space and no development is anticipated. To the south is the rest of the Falcon Ridge development, currently under construction. Property to the west is developed with multi-family housing, at a more intense level than the proposed project.

(c) Existing Structures. A description of the location, physical characteristics, condition and proposed use of any existing structures.

FALCON RIDGE NORTH TENTATIVE MAP

Not applicable. There are no existing onsite structures.

- (d) Existing Vegetation. A description of existing vegetation, including limits of coverage, and major tree sizes and types. In the instance of heavily wooded sites, typical tree sizes, types and limits of tree coverage may be substituted.

The Falcon Ridge North site has been graded in the past under previous permits. The site is therefore mostly bare. There are some trees along the southern property edge, primarily in the drainage channel. These trees can remain in place with this project.

- (e) Prevailing Winds. An analysis of prevailing winds.

Prevailing winds in the area are from west to east with occasional northerly winds during storm events. The project is sheltered from these winds by existing topography, with higher slopes to the north and west.

- (f) Topography. An analysis of slopes on the site using contour interval of five (5) feet, or at a contour interval appropriate for the site and agreed to by the Director of Community Development.

The engineering plans included with this application depict the site topography. Slopes on the site were previously graded as part of prior project approvals associated with Falcon Ridge. This work was approved under and is consistent with the Falcon Ridge Specific Plan.

- (g) Soil. An analysis of the soil characteristics of the site using Soil Conservation Service (SCS) information.

A preliminary geotechnical report is included as an appendix to this report and identifies no soil or geologic conditions that would preclude residential development.

- (h) Natural Drainageways. Identification of natural drainageways on and adjacent to the site.

Natural drainage that occurs along the southern portion of the site will be retained and is incorporated into the provided open space. This is a partially natural and partially engineered drainageway and is identified on the included engineering plans. A detailed hydrology study is also included as an appendix to this report.

Note that refinements to the current FEMA mapping will occur as this site is analyzed further. The existing FEMA map data is highly general and needs to be analyzed using accurate data. This work is currently underway. The project does not propose any work in this drainageway. One component of the project design is to include enough open space area to allow for backwater flow from this drainageway, if necessary. The exact height of water within this drainageway will be refined through additional analysis.

- (i) Wetlands and Water Bodies. Identification of existing or potential wetlands and water bodies on the site.

The included plans identify the drainageway on the southern part of the site. The project has a permitted crossing of the drainageway on site, obtained as part of previous entitlements for the area. No additional work in this drainageway is planned.

(j) Flood Hazards. Identification of existing and potential flood hazards using Federal Emergency Management Agency (FEMA) information.

The drainageway across the southern portion of the site is classified as a flood hazard area. This area is incorporated into the open space and does not occur within any of the proposed lot areas. This area is also depicted on the engineering plans and addressed in the included hydrology report.

(k) Seismic Hazards. Identification of seismic hazards on or near the site, including location of Holocene faults.

A preliminary geotechnical report is included with this application. No known seismic hazards are identified.

(l) Avalanche Hazards. An analysis of avalanche and other landslide hazards.

Not applicable. There are no landslide areas on the site.

(m) Sensitive Habitat and Migration Routes. An analysis of sensitive habitat areas and migration routes.

Not applicable. There are no known or identified sensitive habitats or migration routes onsite.

(n) Significant Views. A description and analysis of all on and off-site significant views.

Views from the site generally are toward the south, which contains the Falcon Ridge project. The site sits lower than the surrounding developed parcels and therefore does not present an impact to existing views.

(o) Easements. A description of the type and location of any easements on the site.

All existing and proposed easements are clearly depicted on the engineering plans included with this report. Additionally, a preliminary title report is being submitted with the original report that identifies and describes all existing easements.

(p) Utilities. A description of existing or available utilities, and an analysis of appropriate locations for water, power, sanitary sewer and storm water sewer services.

The attached engineering plans and drawings depict all existing utilities/infrastructure and proposed extensions, etc. The project will connect to all municipal services including sewer, water, natural gas, cable television, etc.

(q) *Appropriate Access Points.* An analysis of appropriate access points based upon existing and proposed streets and highways and site opportunities and constraints.

Access is provided from El Rancho Drive, through the Falcon Ridge project. Comprehensive traffic analysis occurred with the approval of the Falcon Ridge Specific Plan.

(r) *Other Information.* All other information deemed appropriate and necessary by the Director of Community Development.

This report provides for all pertinent and required details. Additional information and analysis can be provided on an as-needed basis as it may arise during the public review process.

Section 110.408.35 Roads. To the extent possible, common roads and driveways shall be used for access. The roads shall be aligned to follow natural features and topography where possible.

Proposed roads follow the existing grades. The project shares access with the rest of the Falcon Ridge project.

Section 110.408.40 Parking. The parking requirements of Article 410, Parking and Loading, shall apply.

The project meets the required parking standard, including the provision of 15 guest parking spaces distributed around the project area.

Section 110.408.45 Conditions of Approval. Provisions for the common open space development shall be conditioned upon approval of the tentative subdivision or parcel map.

The project will comply with this requirement.

(a) *Three-Year Maintenance Plan.* Provisions shall be made to monitor and maintain, for a period of three (3) years regardless of ownership, a maintenance plan for the common open space area. The maintenance plan for the common open space area shall, as a minimum, address the following:

- (1) *Vegetation management;*
- (2) *Watershed management;*
- (3) *Debris and litter removal;*
- (4) *Fire access and suppression;*
- (5) *Maintenance of public access and/or maintenance of limitations to public access; and*
- (6) *Other factors deemed necessary by the Planning Commission or the Board of County Commissioners.*

The project will maintain an HOA/LMA that will be responsible for common area management.

(b) *Permanent Preservation and Maintenance.* Provisions shall be made for the permanent preservation and ongoing maintenance of the common open space and other common areas using a legal instrument

acceptable to the County.

The project will maintain an HOA/LMA that will be responsible for common area management.

(c) Screening and Buffering of Adjoining Development. Provisions shall be made to assure adequate screening and buffering of existing and potential developments adjoining the proposed common open space development.

Surrounding property is generally higher than the project site. Therefore, the site is naturally screened from these adjoining properties because they look down on the project. Nonetheless, there is a generous open space area between the housing lots and the multi-family development to the west.

(d) Common Open Space Restrictions. Designated common open space shall not include areas devoted to public or private vehicular streets or any land which has been, or is to be, conveyed to a public agency via a purchase agreement for such uses as parks, schools or other public facilities.

The project conforms to this requirement.

Potential Impacts

This section provides an analysis of likely impacts from the project, based on the Tentative Map plans.

Traffic

The project is modestly sized and will not have a significant impact on area traffic. Overall traffic impacts were analyzed during the approval of the Falcon Ridge Specific Plan and this tentative map is a continuation of that approval.

The 52 housing units of Falcon Ridge North are anticipated to generate 302 average daily trips, with 23 trips during the AM peak and 27 trips during the PM peak (ITE Trip Generation 9th Edition, Land use 230 Condo/Townhouse). Area streets can easily handle traffic generation of this magnitude.

Schools

As part of this Tentative Map process, Washoe County School District information was reviewed. The project site is zoned for the following schools: Allen Elementary School, Traner Middle School, and Hug High School. Using WCSD student generation rates, the project is expected to generate: 9 high school students, 4 middle school students, and 4 elementary school students. Given these moderate numbers of new students and the recent increased tax revenue for school construction, it is anticipated that school impacts will be manageable.

Public Facilities/Infrastructure

The project site is located in an area of existing infrastructure. All municipal services (i.e. water, sewer, storm drain, etc.) are either in place or can easily be extended (at the developer's expense) to serve Falcon Ridge North. Power, natural gas, cable television, and high-speed internet service all exist at or adjacent to the project site. Another noteworthy point is that the proposed clustering of units (through a common open space subdivision) will result in resource conservation, reduction in water use, etc. All of the applicable infrastructure is analyzed with the preliminary engineering plans and reports included with this report and compliance is demonstrated.

Preliminary utility plans are included with the engineering plans located in the map pocket of this report.

Public Services

The property is within an acceptable response time of the Truckee Meadows Fire Protection District. The closest Truckee Meadows fire station (Station 45) is located roughly 2.75 miles away (driving distance) and is therefore able to provide adequate service to the site. The Washoe County Sheriff's Office has existing patrols within the project area.

Grading

The site has been previously graded with prior permits. It is currently in an unfinished state with dirt storage piles from ongoing construction of Falcon Ridge. Continuing the buildout of the Falcon Ridge Specific Plan area is the best method to ensure the site is finished with engineered drainage and road access. Grading associated with this Tentative Map was approved as part of previous entitlements, as exhibited by the retaining walls that are already in place on the site. Completing this Tentative Map will reduce visual impacts to the area by removing existing dirt piles and finalizing drainage facilities.

Planning Policy Analysis

The proposed request conforms to the goals and policies of the Sun Valley Area Plan and the Falcon Ridge Specific Plan. Each of these planning documents is addressed below:

Sun Valley Area Plan

The Sun Valley Area Plan is an element of the Washoe County Master Plan that establishes the overall theme and vision of the community over the next 20 years. Last updated in 2010, there has been very little change within the plan area in the last few years. However, as the region's economy continues to recover, there is now opportunity to implement change within the plan area, consistent with the goals and policies of the Area Plan.

The Introduction section of the Area Plan states that the vision of the plan is to *"Manage growth and its*

FALCON RIDGE NORTH TENTATIVE MAP

associated impacts in Sun Valley, focusing on preserving the surrounding public lands and upgrading the quality of the built environment while respecting private property rights.”

This Tentative Map request is entirely consistent with this vision. It manages growth by building out an already planned and approved Specific Plan rather than extending development onto outlying land. The project also includes open space and quality architecture and design.

The Area Plan also establishes an overall Character Statement. The project contributes in multiple ways to furthering the goals of the Character Statement. Specifically, the character statement encourages:

- a mix of housing types
- denser development on the north side of El Rancho Drive
- provision of open space

The proposed project is in direct conformance with these goals. The project site is also within the suburban character management area, an area suitable for development of this type. The suburban character area allows for a maximum of 21 units per acre, well above what is proposed with this project.

Falcon Ridge Specific Plan

The site is subject to the standards contained within the Falcon Ridge Specific Plan. This plan was approved by Washoe County and describes allowable development on the subject parcel and the adjacent area to the south. Per the Plan, the purpose is *“is to provide for a high quality multi-family and attached single family residential project that respects the natural site features through careful placement of homes, preservation of open space, and hillside sensitive grading techniques.”*

The project conforms to this purpose through both the proposed use (attached single family) and the design that preserves open space and minimizes grading.

The Specific Plan includes goals such as *“Guarantee compatibility with adjacent existing developments by utilizing landscaped buffer areas, building height restrictions, curtailment of light pollution, and a maximum density of 269 dwelling units.”*

The proposed project includes landscaped buffer areas, particularly on the western edge where the project is adjacent to existing multi family development. The project conforms to the 35’ height limit, lighting controls, and density restrictions.

The Specific Plan devotes considerable attention to grading practices. It states: *The grading considerations defined in Falcon Ridge Specific Plan will grade as little as possible and will follow the contours of the earth reshaping as needed. Moreover, the entire property has already been graded with the last approved development and the new design will take advantage of the existing grading that has already occurred. Any new grading will follow these goals which include: 1. Minimize disruption to natural topography. 2. Utilization of natural contours and slopes 3. Complement the natural characteristics of the landscape. 4.*

FALCON RIDGE NORTH TENTATIVE MAP

Limit grading in the drainage way to the design of the boxed culvert. 5. Limit fill in the drainage way to the design of the boxed culvert. 6. Use of rockery walls and benching. 7. Preserve natural rock outcroppings. 8. Use erosion control by slope stabilization runoff controls, collection features and Best Management Practices (BMP).

The proposed project advances all of these grading goals. The project minimizes grading disruption by avoiding the steepest site sections. The project does not propose to grade in the drainageway except for the required box culvert at the road crossing. The site already includes rockery walls and benching and there are no rock outcroppings. The project will utilize BMPs.

Specific Standards:

Parking: Every townhome is required to have four spaces, two from a garage and two in front of the residence. The project provides this.

Building Height: Falcon Ridge is limited to 35' building height. The project conforms to this.

Air Quality: the project is required to maintain dust control during construction and to prohibit wood burning stoves as per Washoe County Code. The project will conform to these standards.

Tentative Map Findings

Section 110.608.20 of the Washoe County Development Code establishes legal findings that must be made by the Planning Commission or Board of County Commissioners in order to approve a Tentative Map request. These findings are listed below and are addressed in **bold face** type.

- (a) Environmental and Health Laws. Environmental and health laws and regulations concerning water and air pollution, the disposal of solid waste, facilities to supply water, community or public sewage disposal and, where applicable, individual systems for sewage disposal;

Falcon Ridge North will be served by municipal water and sewer service, ensuring full compliance with this finding. Additionally, solid waste disposal service will be provided through Waste Management which currently operates routes in the surrounding area.

The site is adjacent to existing development and is close to transportation and utility infrastructure. There are no obstacles to providing service to the site.

- (b) Availability of Water. The availability of water which meets applicable health standards as well as requirements for water rights, quality or will-serve commitments;

The project site is effectively within the greater Reno/Sparks urban area. Water and all other services are available on adjacent properties, including the previously constructed portion of Falcon Ridge. Water

FALCON RIDGE NORTH TENTATIVE MAP

rights will be dedicated to TMWA to serve the project, ensuring full compliance with this finding. Water rights can be purchased directly from TMWA or on the open market (with full TMWA acceptance). The developer is familiar with this process and has completed it for the adjacent Falcon Ridge construction.

(c) Utilities. The availability and accessibility of utilities;

The project will be served by all municipal utilities, infrastructure, and services as detailed within this report and on the attached engineering plans. As noted, all services are in place on adjacent properties and can easily be extended to this parcel.

(d) Public Services. The availability and accessibility of public services such as schools, police and fire protection, transportation, recreation and parks;

The project is within the Reno/Sparks urban area. Adjacent properties already receive local services. This site does not represent an extension of service areas for providers.

The closest Truckee Meadows fire station (Station 45) is located roughly 2.75 miles away (driving distance) and is therefore able to provide adequate service to the site. The site is already served by sheriff patrols. Schools serving the project are detailed earlier in this report. Given the modest size of the project, student generation is low and area schools can provide service, particularly given the recent school tax approval that is currently allowing for increased school construction.

(e) Plan Consistency. General conformance with the Development Code and Master Plan;

The project is in direct conformance with the Urban Residential Master Plan designation and Low Density Urban zoning. No changes to these designations are required for this project.

The project conforms to the zoning density and to the design standards of the existing Falcon Ridge Specific Plan. Additionally, the project matches the existing Falcon Ridge development to the south.

(f) Impact on Existing Streets. The effect of the proposed subdivision on existing public streets and the need for new streets or highways to serve the subdivision;

Traffic impacts were thoroughly analyzed with the approval of the Falcon Ridge Specific Plan. This project is following through on the previous approvals associated with the site. Therefore, area roads have already been reviewed and deemed sufficient to serve this project. No new driveways or public road sections are required for this project.

In general, this Tentative Map is modestly sized and does not meet the threshold for a traffic study. Note however that traffic improvements from the Falcon Ridge project are continuing in the area, including a new traffic light scheduled to be installed at the main project entrance on El Rancho Drive. This light will improve safety for area, both for pedestrians and for drivers.

FALCON RIDGE NORTH TENTATIVE MAP

(g) Physical Characteristics. Physical characteristics of the land such as flood plain, slope and soil;

The site is well suited for the type and intensity of development proposed. The site contains no slope or soil conditions that would preclude development nor does it contain any significant wildlife habitats, etc. The site has been previously graded in preparation for this project. This previous grading required engineering review and evaluation, during which the site was found to be suitable for development.

The site is primarily *FEMA Flood Zone X Area of Minimal Flood Hazard*. The site has been subject to grading in the past and includes a drainageway on the south side of the project site that is a combination of natural and engineered topography. This drainageway will be maintained with this project. Box culverts installed as part of this project will be sized to accommodate storm flows. The existing retaining walls on the project site were set at elevations that are clear of the drainageway, based on previous site analysis.

Additional engineering review and documentation accompanies this application.

(h) Agency Review. The recommendations and comments of the entities reviewing the tentative map; and

Copies of this report and the included plans will be circulated to all applicable reviewing agencies for review and comment. Specific requirements and relevant comments can be included as conditions tied to this request and implemented with final map(s).

(i) Impact on Existing Drainage System. The effect of the proposed subdivision on the existing natural and man-made drainage system.

The project will provide for onsite detention to ensure that no additional flows over what currently exist will occur from the site. A detailed hydrology study is also included in the appendices of this report demonstrating compliance with all applicable Washoe County requirements related to drainage.

APPENDIX

Washoe County Development Application

Your entire application is a public record. If you have a concern about releasing personal information, please contact Planning and Building staff at 775.328.6100.

Project Information		Staff Assigned Case No.: _____	
Project Name: Falcon Ridge North			
Project Description: 52-lot townhome subdivision, with common open space, connected to an existing phase of Falcon Ridge (WAC18-0001)			
Project Address: 0 Falcon Rock Lane, Washoe County			
Project Area (acres or square feet): 6.19 acres			
Project Location (with point of reference to major cross streets AND area locator): Falcon Rock Lane off El Rancho Drive			
Assessor's Parcel No.(s):	Parcel Acreage:	Assessor's Parcel No.(s):	Parcel Acreage:
035-721-02	6.19		
Indicate any previous Washoe County approvals associated with this application: Case No.(s).			
Applicant Information (attach additional sheets if necessary)			
Property Owner:		Professional Consultant:	
Name: Falcon Ridge by Desert Wind LP		Name: Rubicon Design Group	
Address: 550 California Avenue		Address: 1610 Montclair Avenue, Suite B	
Reno, NV	Zip: 89509	Reno, NV	Zip: 89509
Phone: 775-626-1800	Fax:	Phone: 775-527-6710	Fax:
Email: Chris Fawcett <cf@desertwindhomes.com>		Email: dwilson@rubicondesigngroup.com	
Cell:	Other:	Cell: 775-527-6710	Other:
Contact Person: Chris Fawcett		Contact Person: Derek Wilson	
Applicant/Developer:		Other Persons to be Contacted:	
Name: same as owner		Name: TEC Civil Engineering	
Address:		Address: 9429 Double Diamond Pkwy, Suite A	
	Zip:		Zip:
Phone:	Fax:	Phone:	Fax:
Email:		Email: jgilles@tecreno.com	
Cell:	Other:	Cell: 775-846-0164	Other:
Contact Person:		Contact Person: Jason Gilles	
For Office Use Only			
Date Received:	Initial:	Planning Area:	
County Commission District:		Master Plan Designation(s):	
CAB(s):		Regulatory Zoning(s):	

Tentative Subdivision Map Application Supplemental Information

(All required information may be separately attached)

1. What is the location (address or distance and direction from nearest intersection)?

Falcon Rock Lane off El Rancho Drive, north side of existing Falcon Ridge development.

2. What is the subdivision name (proposed name must not duplicate the name of any existing subdivision)?

Falcon Ridge North

3. Density and lot design:

a. Acreage of project site	6.19
b. Total number of lots	52
c. Dwelling units per acre	8.4
d. Minimum and maximum area of proposed lots	960 sf min., 1,477 sf max
e. Minimum width of proposed lots	20 linear feet
f. Average lot size	1258 sf

4. What utility company or organization will provide services to the development:

a. Sewer Service	Washoe County/Sun Valley GID
b. Electrical Service	NV Energy
c. Telephone Service	AT&T
d. LPG or Natural Gas Service	NV Energy
e. Solid Waste Disposal Service	Waste Management
f. Cable Television Service	Charter
g. Water Service	TMWA

5. For common open space subdivisions (Article 408), please answer the following:

- a. Acreage of common open space:

4.69 acres

- b. What development constraints are within the development and how many acres are designated slope, wetlands, faults, springs, and/or ridgelines:

The site is previously approved for development. The attached report addresses the site suitability for this project.

- c. Range of lot sizes (include minimum and maximum lot size):

960 sf min., 1,477 sf max

d. Proposed yard setbacks if different from standard:

This project is designed so that the housing lots match the building footprints. This matches previous development in Falcon Ridge.

e. Justification for setback reduction or increase, if requested:

To match existing development within Falcon Ridge.

f. Identify all proposed non-residential uses:

None.

g. Improvements proposed for the common open space:

The open space is generally not suited for development but the overall project will allow access to area open space and trails.

h. Describe or show on the tentative map any public or private trail systems within common open space of the development:

The site is too small to provide significant amenities but the design allows for access to area public land.

i. Describe the connectivity of the proposed trail system with existing trails or open space adjacent to or near the property:

Public open space can be accessed at the northeast project corner.

j. If there are ridgelines on the property, how are they protected from development?

There are no ridgelines.

k. Will fencing be allowed on lot lines or restricted? If so, how?

Fencing will be allowed in backyards.

l. Identify the party responsible for maintenance of the common open space:

Falcon Ridge includes an HOA to maintain open space.

6. Is the project adjacent to public lands or impacted by "Presumed Public Roads" as shown on the adopted April 27, 1999 Presumed Public Roads (see Washoe County Engineering website at <http://www.washoecounty.us/pubworks/engineering.htm>). If so, how is access to those features provided?

The project is adjacent to public land but there are no presumed public roads. Nearby access to public land is available from El Rancho Drive.

7. Is the parcel within the Truckee Meadows Service Area?

Yes No

8. Is the parcel within the Cooperative Planning Area as defined by the Regional Plan?

<input type="checkbox"/> Yes	<input checked="" type="checkbox"/> No	If yes, within what city?
------------------------------	--	---------------------------

9. Has an archeological survey been reviewed and approved by SHPO on the property? If yes, what were the findings?

There is no development on the property warranting SHPO review.

10. Indicate the type and quantity of water rights the application has or proposes to have available:

a. Permit #	n/a	acre-feet per year	n/a
b. Certificate #	n/a	acre-feet per year	n/a
c. Surface Claim #	n/a	acre-feet per year	n/a
d. Other #	n/a	acre-feet per year	n/a

a. Title of those rights (as filed with the State Engineer in the Division of Water Resources of the Department of Conservation and Natural Resources):

The project plans to purchase 8.25af of water from TMWA

11. Describe the aspects of the tentative subdivision that contribute to energy conservation:

The project is composed of moderately sized houses using modern insulation, appliances, and light fixtures.

12. Is the subject property in an area identified by Planning and Building as potentially containing rare or endangered plants and/or animals, critical breeding habitat, migration routes or winter range? If so, please list the species and describe what mitigation measures will be taken to prevent adverse impacts to the species:

No.

13. If private roads are proposed, will the community be gated? If so, is a public trail system easement provided through the subdivision?

The project includes private road and a gate. This phase of the project will conform to the development pattern approved with previous phases.

14. Are there any applicable policies of the adopted area plan in which the project is located that require compliance? If so, which policies and how does the project comply?

The project complies with the Sun Valley Area Plan and the Falcon Ridge Specific Plan, as detailed in the attached report.

15. Are there any applicable area plan modifiers in the Development Code in which the project is located that require compliance? If so, which modifiers and how does the project comply?

Development of the site is controlled by the Falcon Ridge Specific Plan.

16. Will the project be completed in one phase or is phasing planned? If so, please provide that phasing plan:

The project is proposing to be developed in a single phase.

17. Is the project subject to Article 424, Hillside Development? If yes, please address all requirements of the Hillside Ordinance in a separate set of attachments and maps.

<input type="checkbox"/> Yes	<input checked="" type="checkbox"/> No	If yes, include a separate set of attachments and maps.
------------------------------	--	---

18. Is the project subject to Article 418, Significant Hydrologic Resources? If yes, please address Special Review Considerations within Section 110.418.30 in a separate attachment.

<input type="checkbox"/> Yes	<input checked="" type="checkbox"/> No	If yes, include separate attachments.
------------------------------	--	---------------------------------------

Grading

Please complete the following additional questions if the project anticipates grading that involves: (1) Disturbed area exceeding twenty-five thousand (25,000) square feet not covered by streets, buildings and landscaping; (2) More than one thousand (1,000) cubic yards of earth to be imported and placed as fill in a special flood hazard area; (3) More than five thousand (5,000) cubic yards of earth to be imported and placed as fill; (4) More than one thousand (1,000) cubic yards to be excavated, whether or not the earth will be exported from the property; or (5) If a permanent earthen structure will be established over four and one-half (4.5) feet high:

19. How many cubic yards of material are you proposing to excavate on site?

42,692 cubic yards

20. How many cubic yards of material are you exporting or importing? If exporting of material is anticipated, where will the material be sent? If the disposal site is within unincorporated Washoe County, what measures will be taken for erosion control and revegetation at the site? If none, how are you balancing the work on-site?

Material balances on site. This balance is created by installing larger detention ponds.
--

21. Can the disturbed area be seen from off-site? If yes, from which directions, and which properties or roadways? What measures will be taken to mitigate their impacts?

The disturbed area can be seen from the unoccupied eastern side property. Completing the site will be a visual improvement.

22. What is the slope (Horizontal/Vertical) of the cut and fill areas proposed to be? What methods will be used to prevent erosion until the revegetation is established?

Max slope will be 3:1 and will be stabilized with rip rap lining.

23. Are you planning any berms and, if so, how tall is the berm at its highest? How will it be stabilized and/or revegetated?

No.

24. Are retaining walls going to be required? If so, how high will the walls be, will there be multiple walls with intervening terracing, and what is the wall construction (i.e. rockery, concrete, timber, manufactured block)? How will the visual impacts be mitigated?

Yes, 8' tall maximum wall height. Some landscape retaining walls will be rockery. Wall construction type will be determined with final design.
--

25. Will the grading proposed require removal of any trees? If so, what species, how many, and of what size?

No tree removal.

26. What type of revegetation seed mix are you planning to use and how many pounds per acre do you intend to broadcast? Will you use mulch and, if so, what type?

Reveg. seed mix will match landscape plan recommendations.

27. How are you providing temporary irrigation to the disturbed area?

Irrigation will be provided.

28. Have you reviewed the revegetation plan with the Washoe Storey Conservation District? If yes, have you incorporated their suggestions?

Revegetation plan will follow standard local practices and requirements.

Property Owner Affidavit

Applicant Name: Falcon by Desert Wind

The receipt of this application at the time of submittal does not guarantee the application complies with all requirements of the Washoe County Development Code, the Washoe County Master Plan or the applicable area plan, the applicable regulatory zoning, or that the application is deemed complete and will be processed.

STATE OF NEVADA)
COUNTY OF WASHOE)

I, Chris Fawcett
(please print name)

being duly sworn, depose and say that I am the owner* of the property or properties involved in this application as listed below and that the foregoing statements and answers herein contained and the information herewith submitted are in all respects complete, true, and correct to the best of my knowledge and belief. I understand that no assurance or guarantee can be given by members of Planning and Building.

(A separate Affidavit must be provided by each property owner named in the title report.)

Assessor Parcel Number(s): 035-721-01, 035-721-02

Printed Name Chris Fawcett

Signed [Signature]

Address 550 California Ave

Reno, NV 89509

Subscribed and sworn to before me this 14 day of August, 2019.

Melanie Cook

Notary Public in and for said county and state

My commission expires: 7/16/2022

(Notary Stamp)

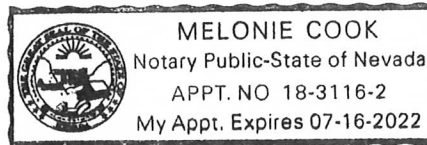

*Owner refers to the following: (Please mark appropriate box.)

- Owner
- Corporate Officer/Partner (Provide copy of record document indicating authority to sign.)
- Power of Attorney (Provide copy of Power of Attorney.)
- Owner Agent (Provide notarized letter from property owner giving legal authority to agent.)
- Property Agent (Provide copy of record document indicating authority to sign.)
- Letter from Government Agency with Stewardship

Bill Detail

Washoe County Parcel Information		
Parcel ID	Status	Last Update
03572102	Active	8/15/2019 2:07:55 AM
Current Owner: FALCON RIDGE BY DESERT WIND LP 550 CALIFORNIA AVE RENO, NV 89509		SITUS: 0 FALCON ROCK LN WASHOE COUNTY NV
Taxing District 4000	Geo CD:	
Legal Description		
Township 20 Section 30 Lot 2 Block Range 20 SubdivisionName FALCON RIDGE		

Installments						
Period	Due Date	Tax Year	Tax	Penalty/Fee	Interest	Total Due
INST 1	8/19/2019	2019	\$844.58	\$0.00	\$0.00	\$844.58
INST 2	10/7/2019	2019	\$844.56	\$0.00	\$0.00	\$844.56
INST 3	1/6/2020	2019	\$844.56	\$0.00	\$0.00	\$844.56
INST 4	3/2/2020	2019	\$844.56	\$0.00	\$0.00	\$844.56
Total Due:			\$3,378.26	\$0.00	\$0.00	\$3,378.26

Tax Detail			
	Gross Tax	Credit	Net Tax
State of Nevada	\$202.42	(\$25.18)	\$177.24
Truckee Meadows Fire Dist	\$642.98	(\$79.98)	\$563.00
Washoe County	\$1,657.10	(\$206.10)	\$1,451.00
Washoe County Sc	\$1,355.62	(\$168.62)	\$1,187.00
TRUCKEE MDWS/SUN VALLEY WATER BASIN	\$0.02	\$0.00	\$0.02
Total Tax	\$3,858.14	(\$479.88)	\$3,378.26

Payment History
No Payment Records Found

Pay By Check

Please make checks payable to:
WASHOE COUNTY TREASURER

Mailing Address:
P.O. Box 30039
Reno, NV 89520-3039

Overnight Address:
1001 E. Ninth St., Ste D140
Reno, NV 89512-2845

Change of Address

All requests for a mailing address change must be submitted in writing, including a signature (unless using the online form).

To submit your address change online [click here](#)

Address change requests may also be faxed to: (775) 328-3642

Address change requests may also be mailed to:
Washoe County Assessor
1001 E 9th Street
Reno, NV 89512-2845

The Washoe County Treasurer's Office makes every effort to produce and publish the most current and accurate information possible. No warranties, expressed or implied, are provided for the data herein, its use, or its interpretation. If you have any questions, please contact us at (775) 328-2510 or tax@washoecounty.us

This site is best viewed using Google Chrome, Internet Explorer 11, Mozilla Firefox or Safari.



August 2, 2019

Chris Fawcett
Falcon Ridge by Desert Wind, LP
550 California Ave
Reno, NV 89509

**RE: Falcon Ridge North
Acknowledgement of Water Service
TMWA Work Order 19-6994**

I have reviewed the plans for the above referenced development (Project) as submitted to the Truckee Meadows Water Authority (TMWA) and have determined that the Project is within TMWA's retail water service area. This letter constitutes an Acknowledgment of Water Service pursuant to NAC 445A.6666, and TMWA hereby acknowledges that TMWA is agreeable to supplying water service to the Project, subject to applicant satisfying certain conditions precedent, including, without limitation, the dedication of water resources, approval of the water supply plan by the local health authority, the execution of a Water Service Agreement, payment of fees, and the construction and dedication of infrastructure in accordance with TMWA's rules and tariffs. This Acknowledgement does not constitute a legal obligation by TMWA to supply water service to the Project, and, is made subject to all applicable TMWA Rules.

Review of conceptual site plans or tentative maps by TMWA does not constitute an application for service, nor implies a commitment by TMWA for planning, design or construction of the water facilities necessary for service. The extent of required off-site and on-site water infrastructure improvements will be determined by TMWA upon receiving a specific development proposal or complete application for service and upon review and approval of a water facilities plan. After submittal of a complete Application for Service, the required facilities, the cost of these facilities, which could be significant, and associated fees will be estimated and will be included as part of the Water Service Agreement for the Project. All fees must be paid to TMWA prior to water being delivered to the Project.

Sincerely,
Truckee Meadows Water Authority

Brooke Long, P.E.

FALCON RIDGE NORTH TENTATIVE MAP



OWNER
 DESERT WIND, LLC
 550 CALIFORNIA AVE.
 RENO, NEVADA 89509

ENGINEER
 TEC CIVIL ENGINEERING CONSULTANTS
 9429 DOUBLE DIAMOND PARKWAY, SUITE A
 RENO, NEVADA 89521

SHEET INDEX

1	PRELIMINARY COVER SHEET
2	PRELIMINARY SITE PLAN
3	PRELIMINARY GRADING PLAN
4	PRELIMINARY UTILITY PLAN
5	PRELIMINARY CROSS-SECTIONS

LEGEND

- PROJECT BOUNDARY
- EXISTING LOT LINE
- ⊗ SECTION CORNER
- TIE LINE
- SET 5/8" REBAR w/ CAP PLS 7998
- FOUND 5/8" REBAR w/ CAP PLS 7998 OR OTHERWISE NOTED
- COMMON AREA TO BE DEDICATED

BOUNDARY LINE TABLE

LINE	LENGTH	DIRECTION
L1	83.07	N 71°04'49" E
L2	17.71	N 35°22'48" E
L3	74.40	N 73°54'46" E
L4	39.96	N 31°43'07" E
L5	71.66	S 40°23'59" W
L6	67.20	S 45°18'41" W
L7	50.14	S 57°48'25" W
L8	61.08	S 80°19'22" W
L9	49.06	S 79°23'05" W
L10	53.64	N 84°02'10" W
L11	19.51	N 62°30'05" W

REFERENCES

- SUBDIVISION TRACT MAP No. 5302, DOCUMENT No. 4873747
- REVERSION TRACT MAP No. 5039, DOCUMENT No. 4244388
- RECORD OF SURVEY MAP No. 3204, DOCUMENT No. 2078934
- SUBDIVISION TRACT MAP No. 4712, DOCUMENT No. 3451625
- PARCEL MAP No. 1555, DOCUMENT No. 891317

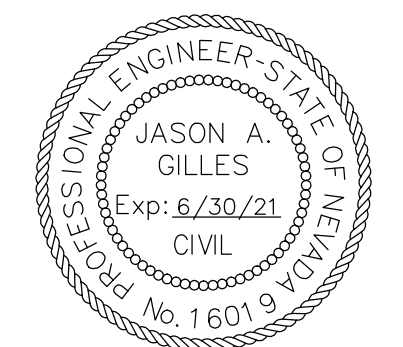

THIS TENTATIVE SUBDIVISION MAP HAS BEEN CREATED AND IS IN COMPLIANCE WITH ALL APPLICABLE PROVISIONS OF THE WASHOE COUNTY DEVELOPMENT CODE:

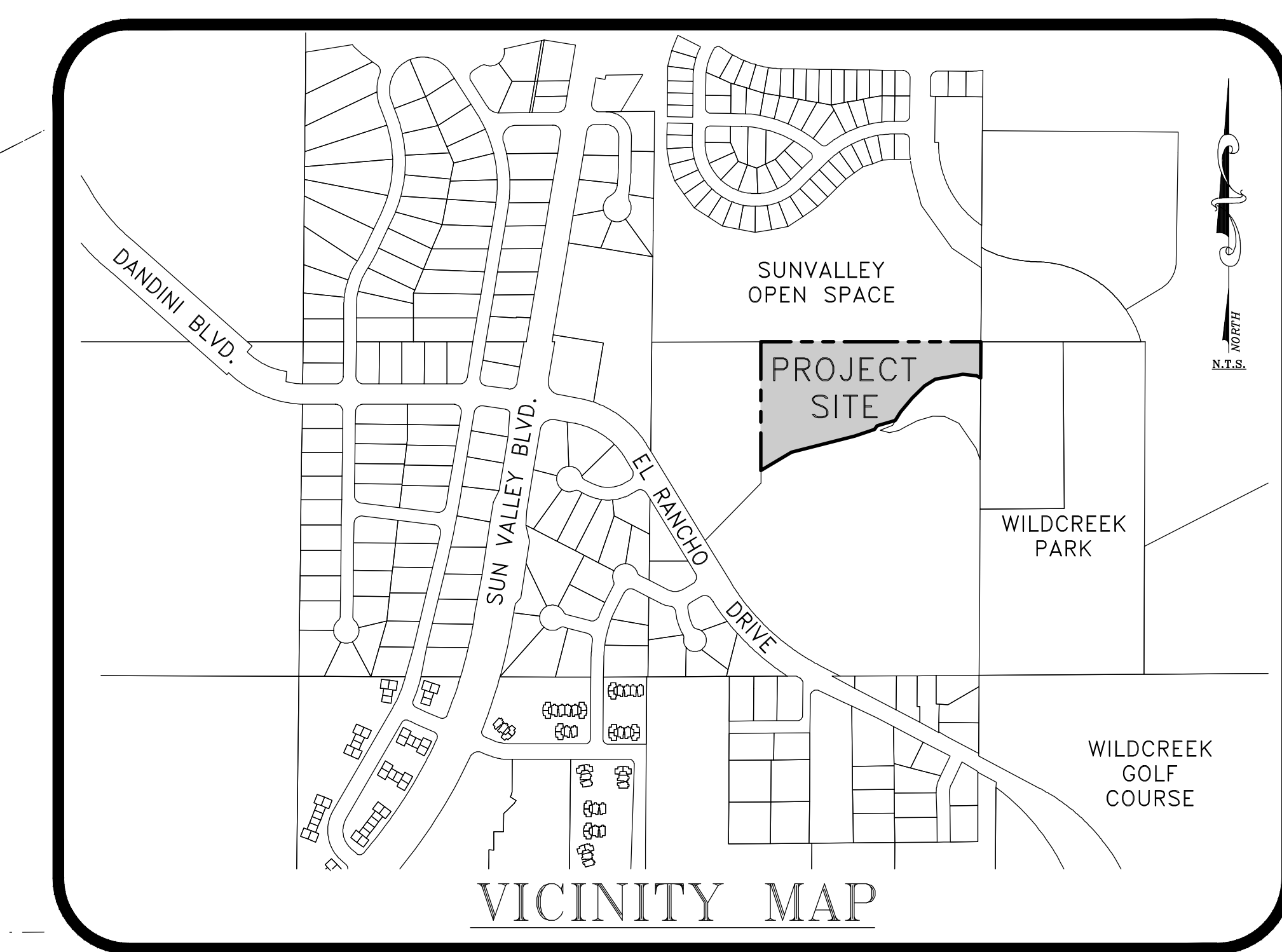

PRELIMINARY COVER SHEET



FALCON RIDGE NORTH TENTATIVE MAP

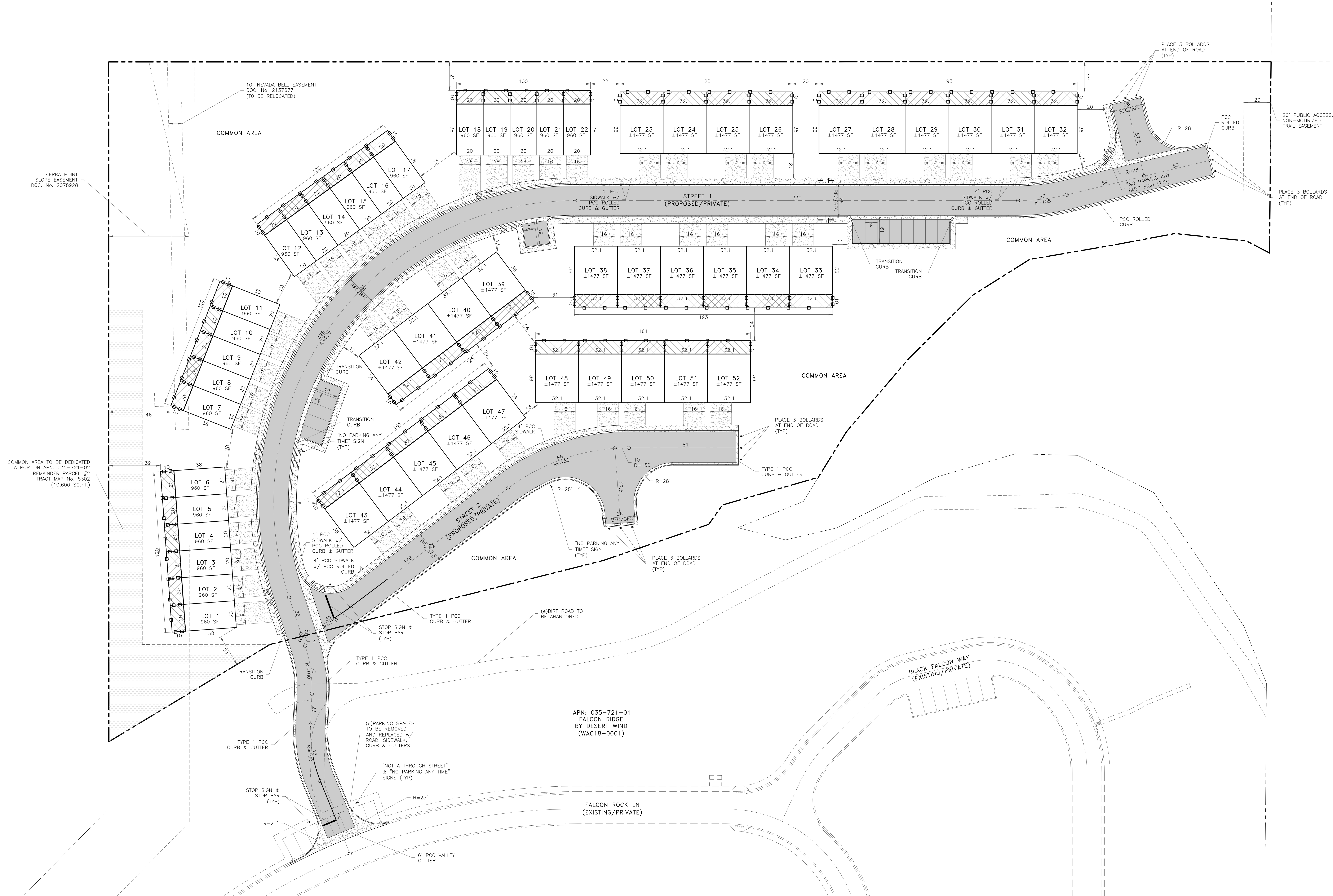

PROJECT / LAND USE DATA

TOTAL NUMBER OF LOTS	52
TOTAL PROJECT AREA	6.19 ACRES
GROSS RESIDENTIAL DENSITY	±322 LOT-ACRES
LOT BREAKDOWN	
SMALLEST LOT SIZE	960 S.F.
LARGEST LOT SIZE	1,477 S.F.
AVERAGE LOT SIZE	871 S.F.
LAND USE BREAKDOWN	
LOT AREA	1.50 ACRES
PRIVATE STREET AREA (TOTAL)	1.01 ACRES
PRIVATE STREET AREA (ON-SITE)	0.90 ACRES
PRIVATE STREET AREA (OFF-SITE)	0.11 ACRES
COMMON AREA	4.42 ACRES
DEDICATED COMMON AREA	0.24 ACRES
CURRENT ZONING	LDU
GUEST SPACES PROVIDED	15 SPACES
*STREET AREA MEASURED BFC/BFC.	
*INCLUDES ON-SITE PRIVATE STREETS.	
DOES NOT INCLUDE DEDICATED PARCEL.	

UTILITY DATA

CABLE	CHARTER COMMUNICATIONS
ELECTRIC	NV ENERGY
GAS	NV ENERGY
SANITARY SEWER (ON-SITE)	WASHOE COUNTY
SANITARY SEWER (OFF-SITE)	SUN VALLEY GID
SOLID WASTE	WASTE MANAGEMENT
TELEPHONE	AT&T
WATER	TRUCKEE MEADOWS WATER AUTHORITY

NOTES:

1. ALL PROPOSED STREETS WITHIN THE TENTATIVE MAP ARE PRIVATELY OWNED AND MAINTAINED BY THE HOA OR EQUIVALENT.
2. REF. SHEET 5 FOR STREET CROSS-SECTIONS.
3. ALL PROPOSED PRIVATE STREETS TO HAVE PAINTED RED CURBS AND "NO PARKING" SIGNAGE.

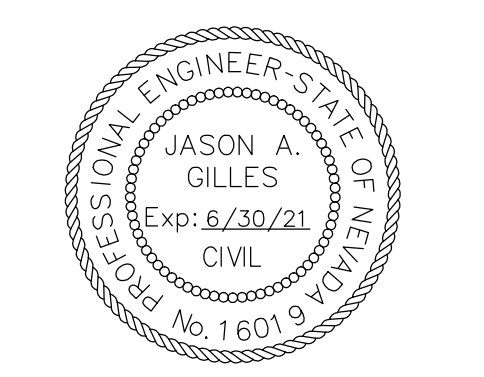

BASIS OF BEARING

THE NAD-83/94 NEVADA STATE PLANE WEST ZONE (EPOCH 2010) COORDINATE GRID BEARINGS FROM THE TRUCKEE MEADOWS REGIONAL GPS "VRS" NETWORK. GROUND COORDINATES ARE SHOWN AND WERE OBTAINED BY MULTIPLYING THE GRID COORDINATES BY A SCALE FACTOR OF 1.000197939 (R/S 2775, R/S 3396, & R/S 3885). ALL DISTANCES SHOWN ARE GROUND DISTANCES.

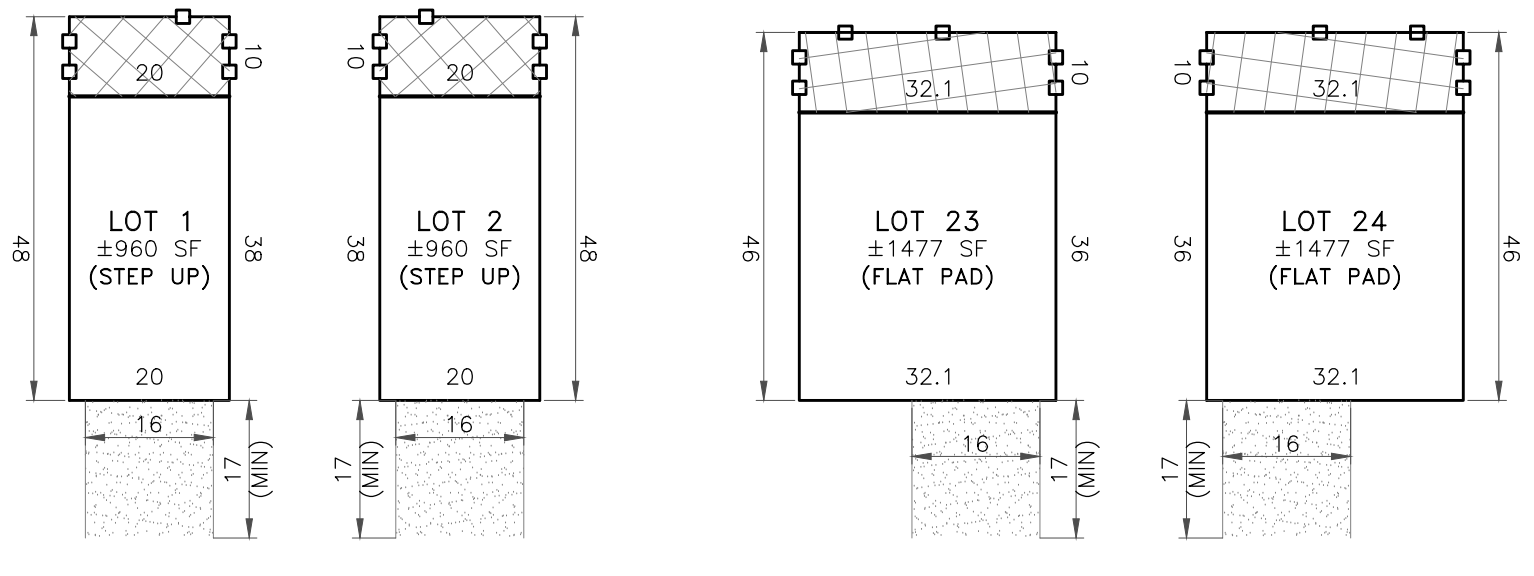

TYPICAL LOT DIMENSIONS
N.T.S.

MODELS 1-22
20' WIDE X 48' DEEP
±960 SF/UNIT
(22 LOTS)

MODELS 23-52
32.1' WIDE X 46' DEEP
±1477 SF/UNIT
(30 LOTS)

LEGEND

	PROJECT BOUNDARY
	EXISTING LOT LINE
	PROPOSED LOT LINE
	PROPOSED A.C. PAVEMENT AREA
	PROPOSED CONCRETE AREA
	PROPOSED FENCED BACKYARD AREA
	PEDESTRIAN RAMP
	EXISTING EASEMENT
	COMMON AREA TO BE DEDICATED

PRELIMINARY SITE PLAN



FALCON RIDGE NORTH TENTATIVE MAP

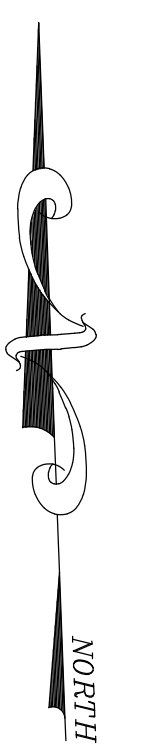

LEGEND

- PROJECT BOUNDARY
- PROPOSED LOT LINE
- A.C. PAVEMENT AREA
- CONCRETE AREA
- PEDESTRIAN RAMP
- STORM DRAIN w/ DIRECTION (DASHED IF EXISTING)
- CATCH BASIN (HOLLOW IF EXISTING)
- STORM DRAIN MANHOLE (HOLLOW IF EXISTING)
- RETAINING WALL (8' MAX HEIGHT)
- GRADE BREAK
- PROPOSED ELEVATION @ FINISHED GRADE
- PROPOSED ELEVATION @ GRADE BREAK
- PROPOSED ELEVATION @ HIGH POINT
- PROPOSED ELEVATION @ BEGINNING OF VERTICAL CURVE
- PROPOSED ELEVATION @ END OF VERTICAL CURVE
- EXISTING CONTOUR LINE
- PROPOSED CONTOUR LINE
- EXISTING LOT LINE
- LOT 3
- LOT NUMBERS
- FEMA FLOOD PLAN BOUNDARY
- SLOPE INDICATOR
- LIMITS OF GRADING

EARTHWORK QUANTITIES

TOTAL PROJECT AREA 6.19 ACRES
 TOTAL DISTURBED AREA 5.28 ACRES
 *TOTAL AREA >30% 1.77 ACRES

*(REF. NOTE 6 ~ THIS SHEET)

CUT = 42,692 Cu.Yds.
 FILL = 42,692 Cu. Yds.
 NET = 0 Cu. Yds.

NOTES:

1. ADD 4500 FEET TO ALL SPOT ELEVATIONS.
2. REF. SHEET 5 FOR CROSS-SECTIONS.
3. ALL 2:1 SLOPES WITHIN DETENTION PONDS TO BE COVERED WITH #8"-12" RIP RAP PER GEOTECHNICAL ENGINEER'S AND/OR LANDSCAPE ARCHITECT'S RECOMMENDATIONS WITH FINAL DESIGN.
4. ALL 3:1 SLOPES TO BE TREATED WITH EITHER DG MULCH, 4" ROCK MULCH OR REVEG SEEDING MIX PER LANDSCAPE ARCHITECT'S RECOMMENDATIONS WITH FINAL DESIGN.
5. PROPER BMP'S TO BE DECIDED UPON WITH FINAL DESIGN.
6. PROJECT SITE HAS BEEN PREVIOUSLY DISTURBED/GRADED. TOTAL AREAS WITH A SLOPE OVER 30% NOT REPRESENTATIVE OF ORIGINAL SITE.

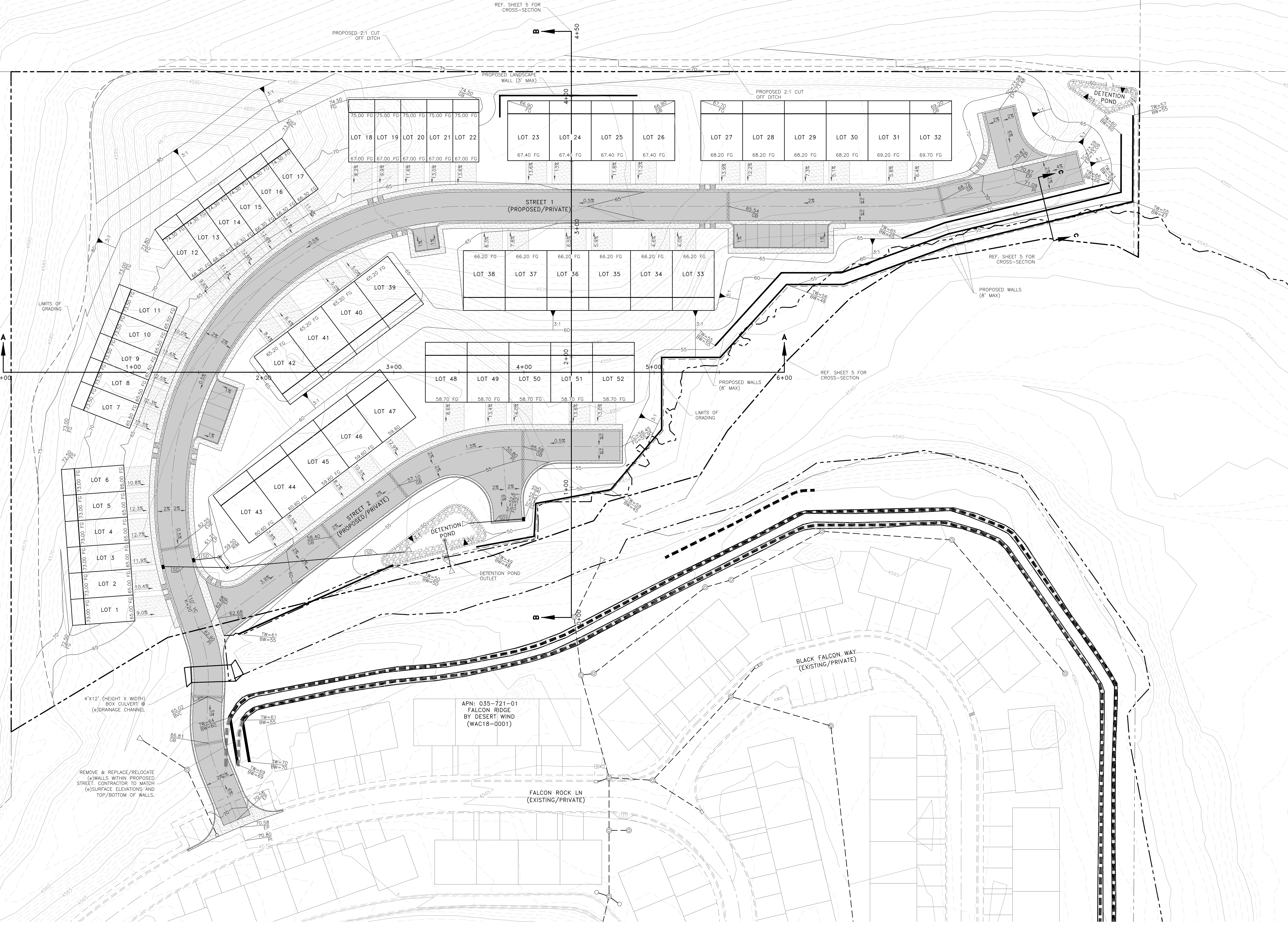

0+00

A

1+00

2+00

3+00

4+00

5+00

6+00

7+00

8+00

9+00

10+00

11+00

12+00

13+00

14+00

15+00

16+00

17+00

18+00

19+00

20+00

21+00

22+00

23+00

24+00

25+00

26+00

27+00

28+00

29+00

30+00

31+00

32+00

33+00

34+00

35+00

36+00

37+00

38+00

39+00

40+00

41+00

42+00

43+00

44+00

45+00

46+00

47+00

48+00

49+00

50+00

51+00

52+00

53+00

54+00

55+00

56+00

57+00

58+00

59+00

60+00

61+00

62+00

63+00

64+00

65+00

66+00

67+00

68+00

69+00

70+00

71+00

72+00

73+00

74+00

75+00

76+00

77+00

78+00

79+00

80+00

81+00

82+00

83+00

84+00

85+00

86+00

87+00

88+00

89+00

90+00

91+00

92+00

93+00

94+00

95+00

96+00

97+00

98+00

99+00

100+00

101+00

102+00

103+00

104+00

105+00

106+00

107+00

108+00

109+00

110+00

111+00

112+00

113+00

114+00

115+00

116+00

117+00

118+00

119+00

120+00

121+00

122+00

123+00

124+00

125+00

126+00

127+00

128+00

129+00

130+00

131+00

132+00

133+00

134+00

135+00

136+00

137+00

138+00

139+00

140+00

141+00

142+00

143+00

144+00

145+00

146+00

147+00

148+00

149+00

150+00

151+00

152+00

153+00

154+00

155+00

156+00

157+00

158+00

159+00

160+00

161+00

162+00

163+00

164+00

165+00

166+00

167+00

168+00

169+00

170+00

171+00

172+00

173+00

174+00

175+00

176+00

177+00

178+00

179+00

180+00

181+00

182+00

183+00

184+00

185+00

186+00

187+00

188+00

189+00

190+00

191+00

192+00

193+00

194+00

195+00

196+00

197+00

198+00

199+00

200+00

201+00

202+00

203+00

204+00

205+00

206+00

207+00

208+00

209+00

210+00

211+00

212+00

213+00

214+00

215+00

216+00

217+00

218+00

219+00

220+00

221+00

222+00

223+00

224+00

225+00

226+00

227+00

228+00

229+00

230+00

231+00

232+00

233+00

234+00

235+00

236+00

237+00

238+00

239+00

240+00

241+00

242+00

243+00

244+00

245+00

246+00

247+00

248+00

249+00

250+00

251+00

252+00

253+00

254+00

FALCON RIDGE NORTH TENTATIVE MAP

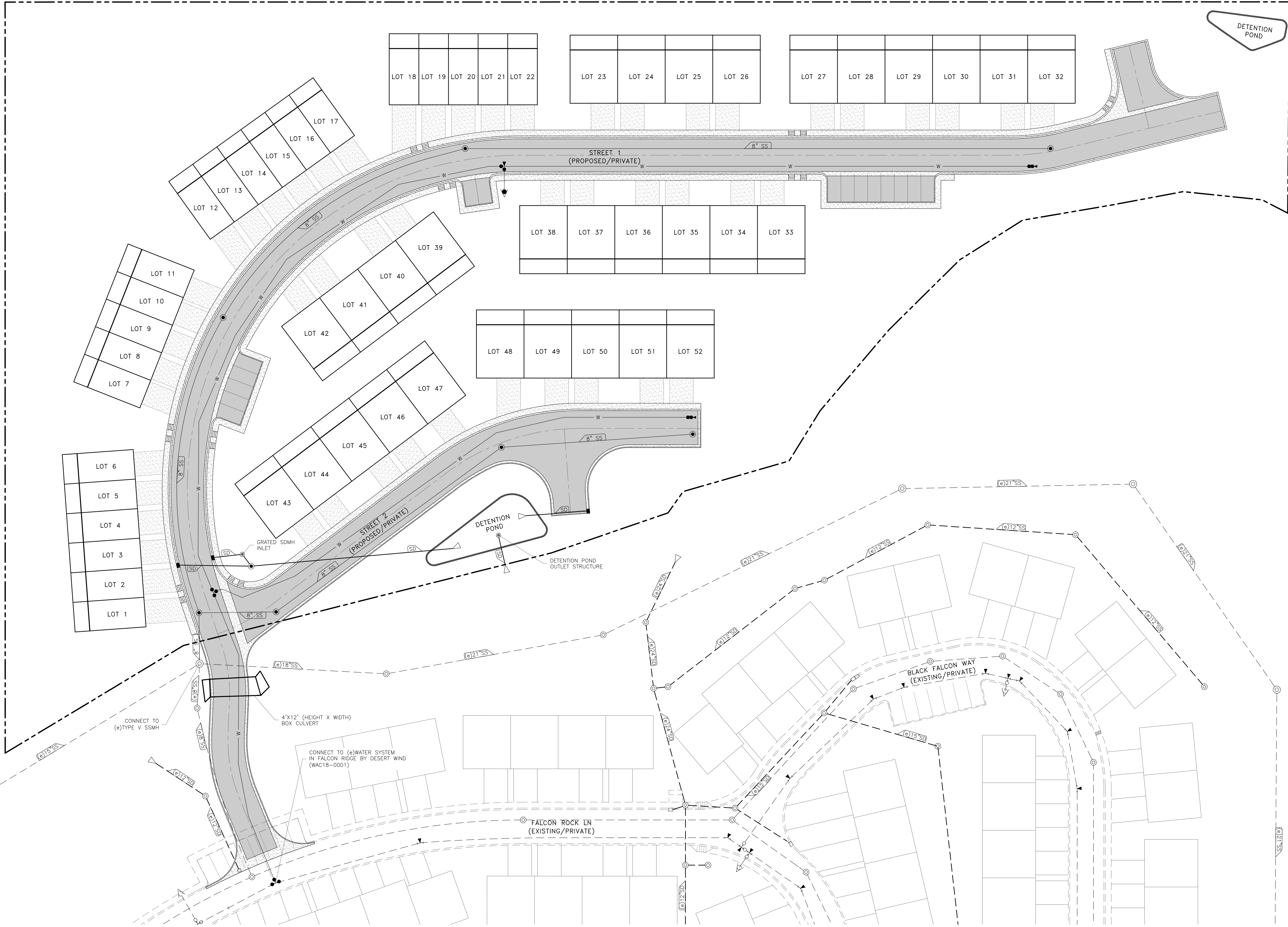

LEGEND

- PROJECT BOUNDARY
- - - PROPOSED LOT LINE
- ▨ A.C. PAVEMENT AREA
- ▩ CONCRETE AREA
- ▧ PEDESTRIAN RAMP
- SD STORM DRAIN w/ DIRECTION (DASHED IF EXISTING)
- SS SANITARY SEWER MAIN w/ DIAMETER & DIRECTION (DASHED IF EXISTING)
- W WATER MAIN w/ GAS (DASHED IF EXISTING)
- CATCH BASIN (HOLLOW IF EXISTING)
- MANHOLE (HOLLOW IF EXISTING)
- FIRE HYDRANT (HOLLOW IF EXISTING)

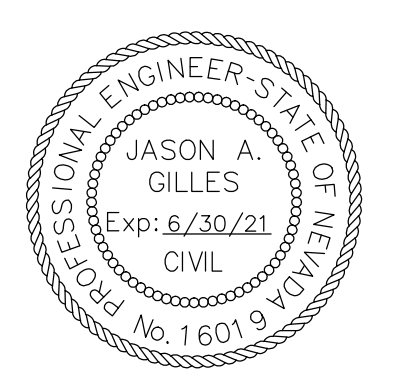

- NOTES:**
1. PROPOSED STORM DRAIN SYSTEM TO BE PUBLICLY OWNED AND MAINTAINED.
 2. PROPOSED GRAVITY SANITARY SEWER SYSTEM TO BE PUBLICLY OWNED AND MAINTAINED.
 3. PROPOSED WATER SYSTEM TO BE OWNED AND MAINTAINED BY THE TRUCKEE MEADOWS WATER AUTHORITY (TMWA).
 4. PROPOSED DETENTION PONDS TO BE PRIVATELY OWNED AND MAINTAINED BY THE HOA OR EQUIVALENT.
 5. DETENTION POND OUTLET STRUCTURE TO BE SIZED WITH FINAL DESIGN.



PRELIMINARY UTILITY PLAN

FALCON RIDGE NORTH TENTATIVE MAP

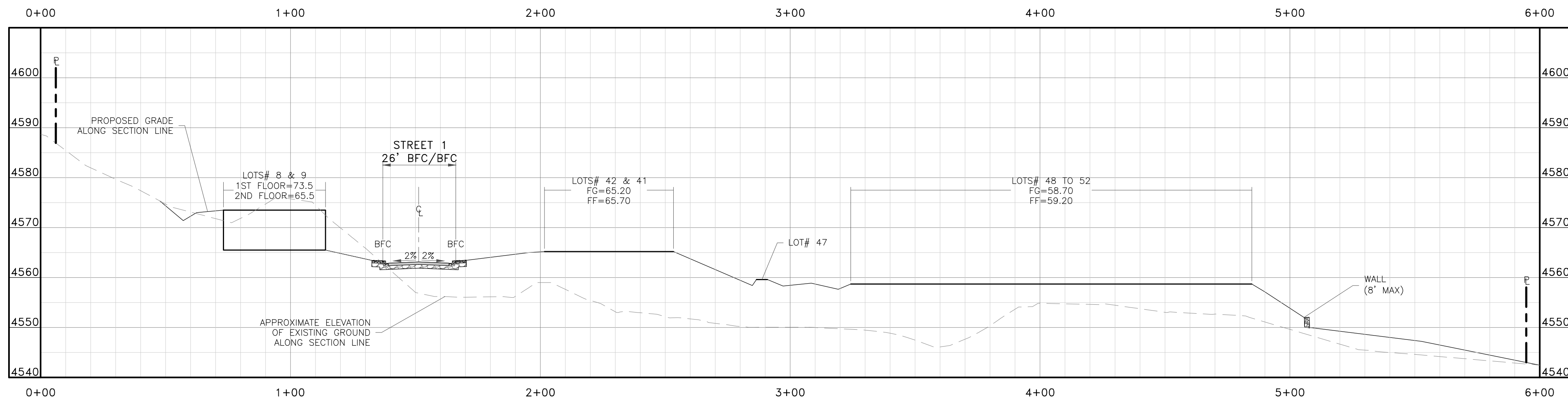
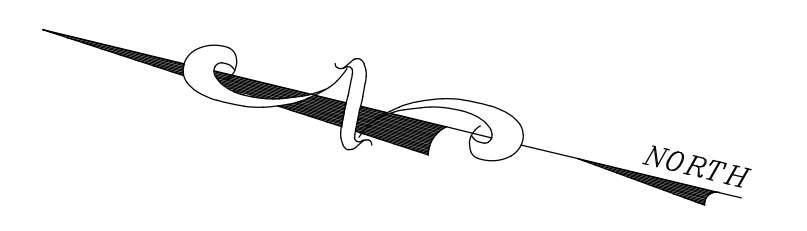
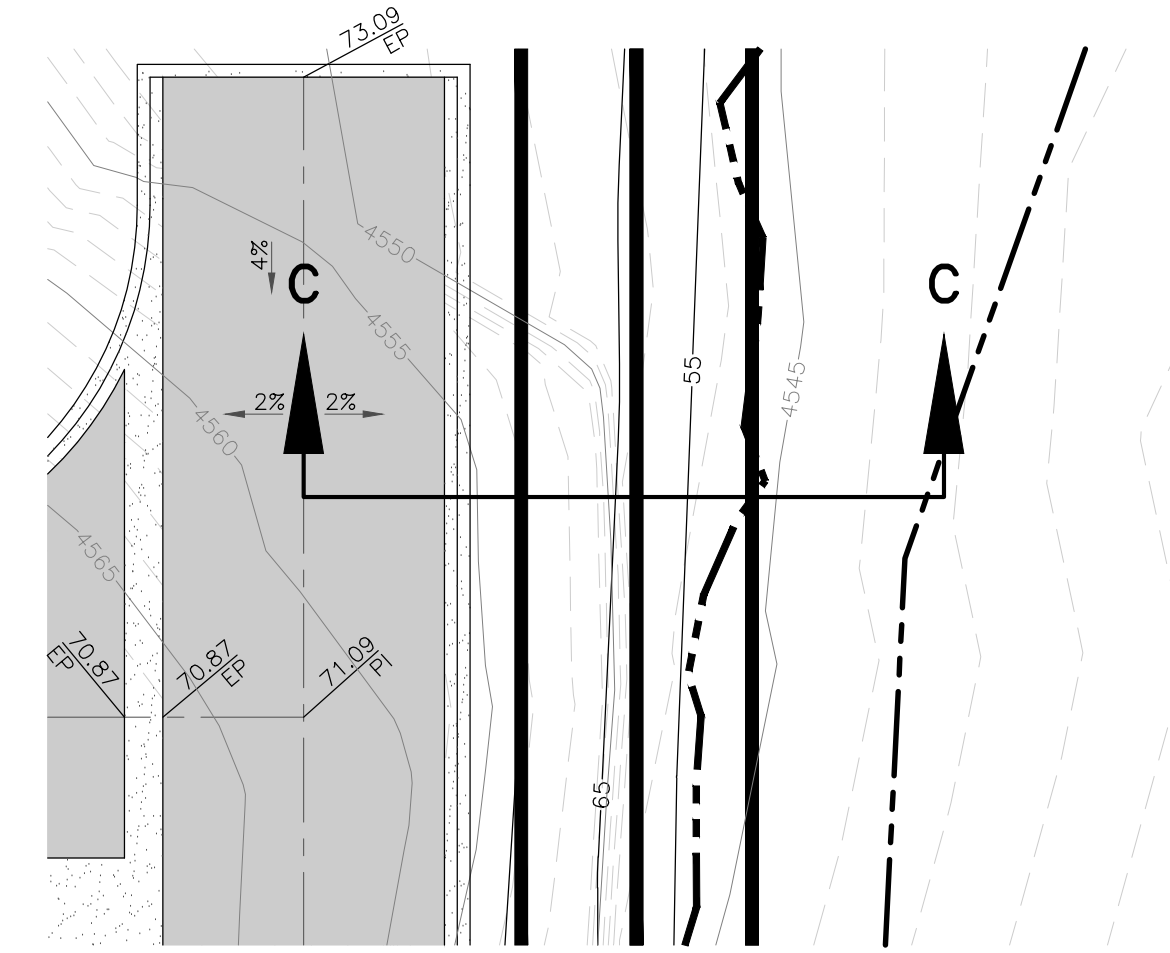
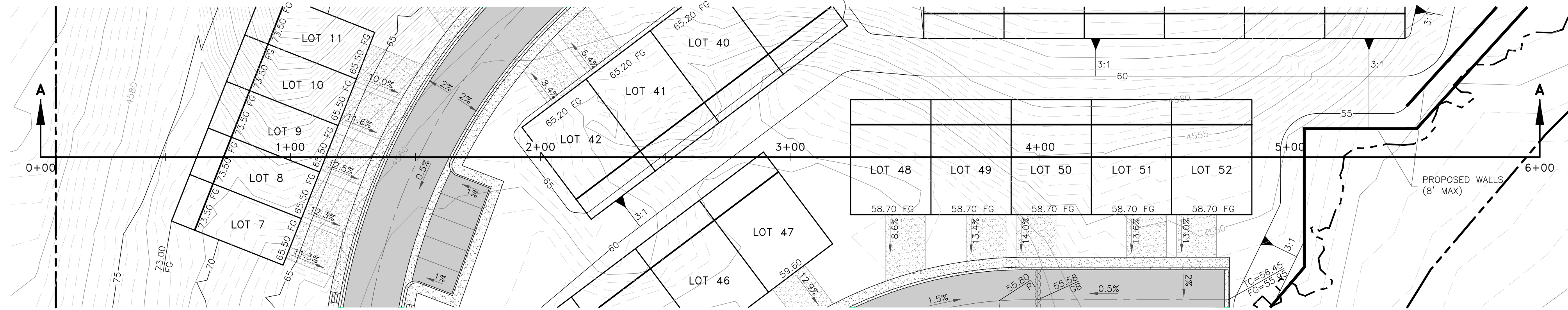

SECTION A-A

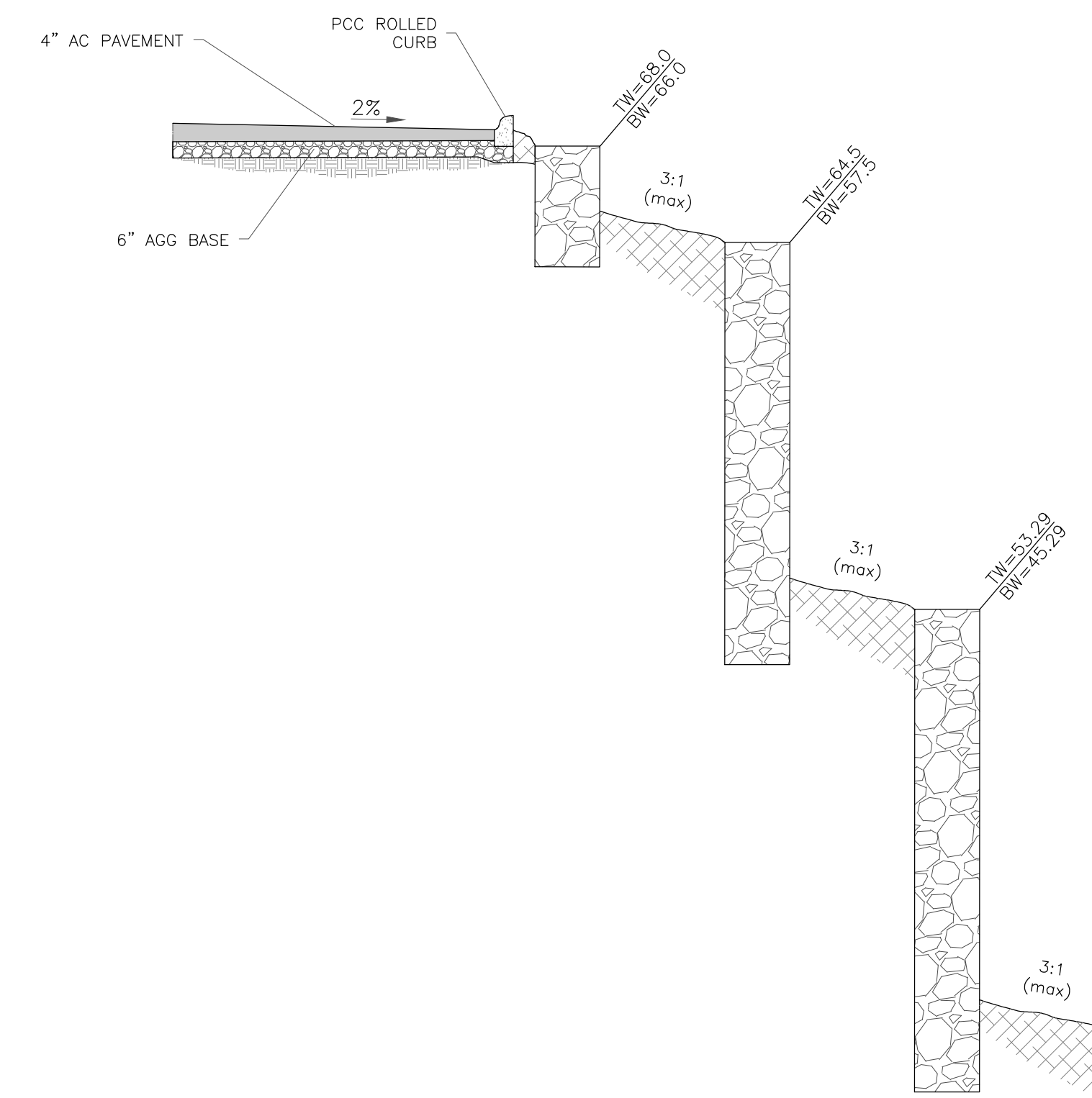

SECTION C-C
(N.T.S.)

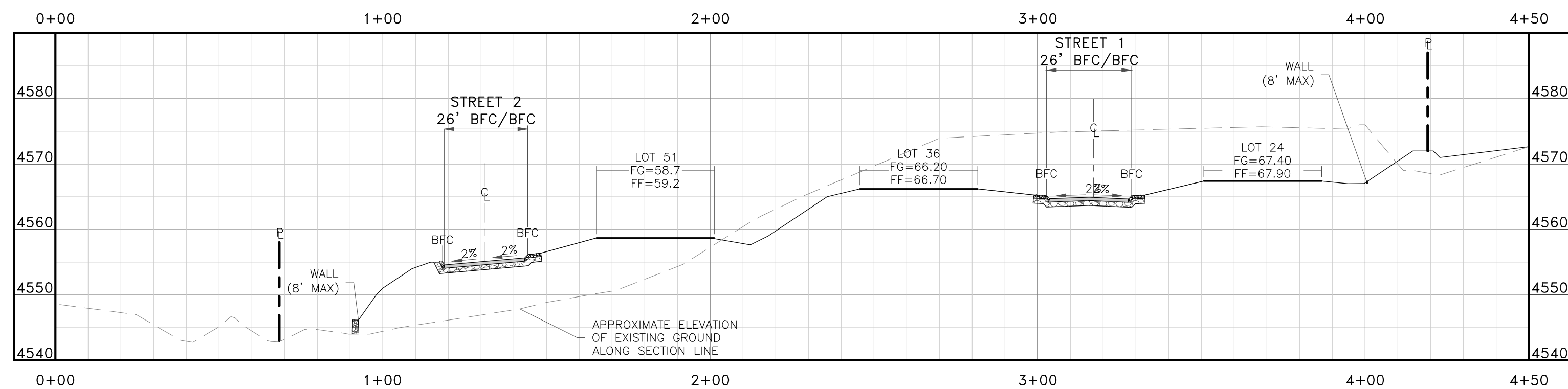
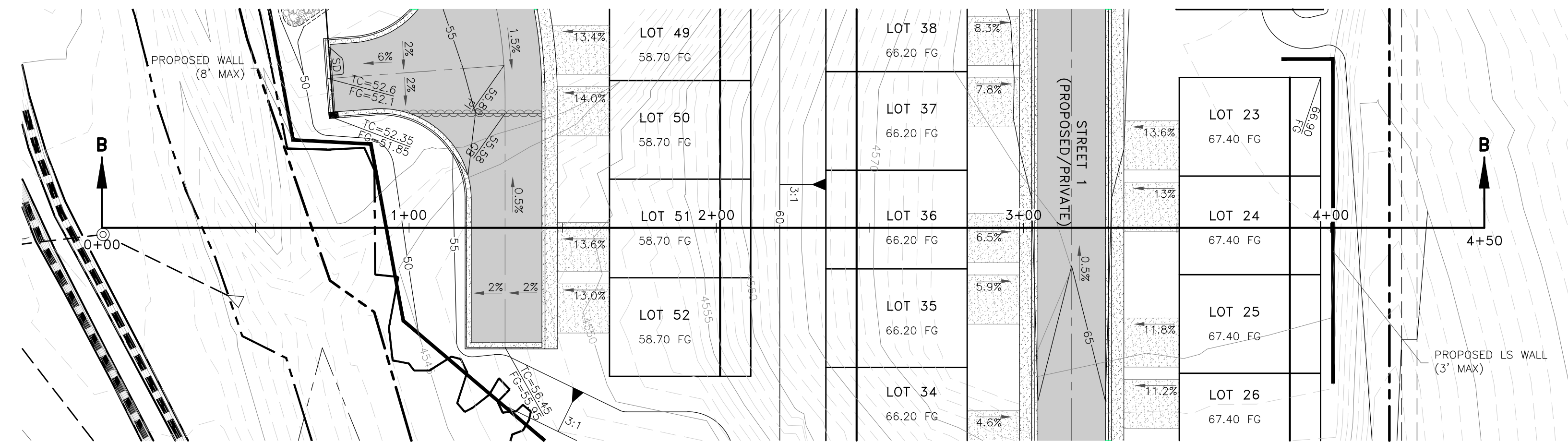
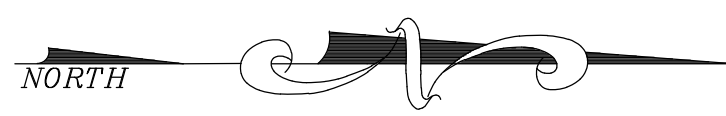

SECTION B-B

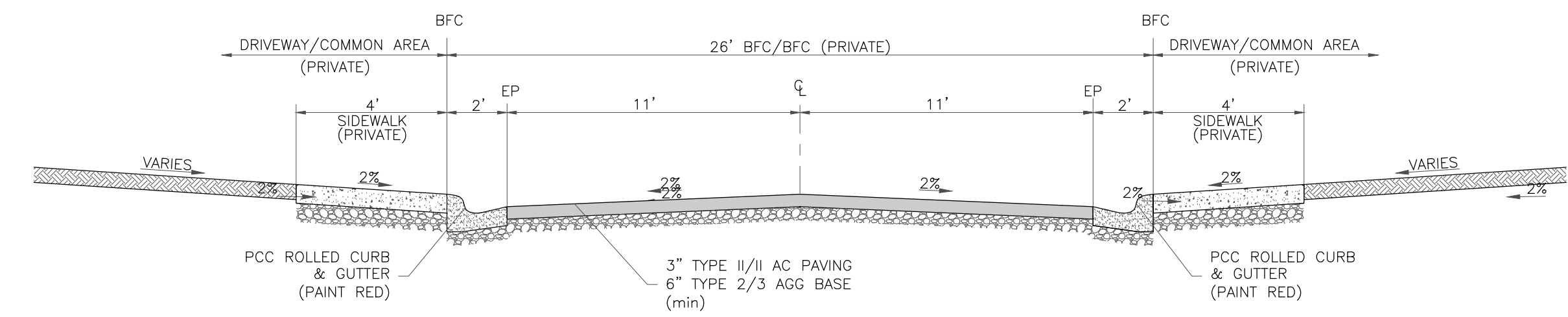

STREET 1 (PRIVATE)
NO PARKING (N.T.S.)

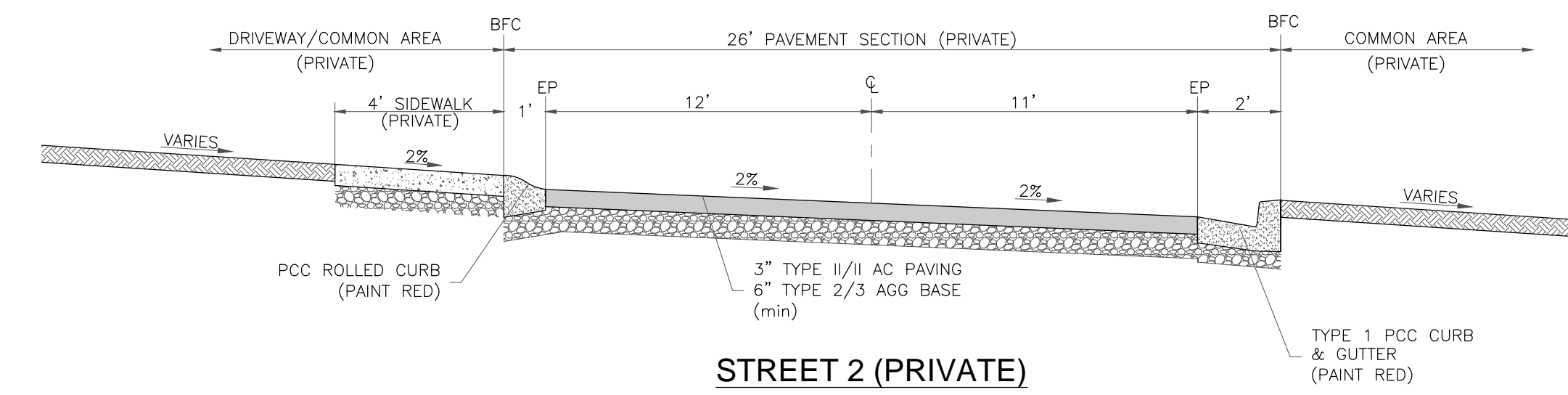

STREET 2 (PRIVATE)
NO PARKING (N.T.S.)

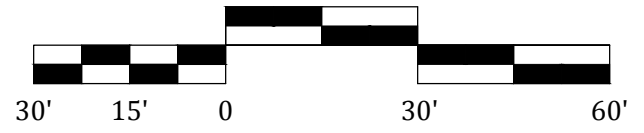

HORIZONTAL SCALE
1"=30'

VERTICAL SCALE
1"=15'

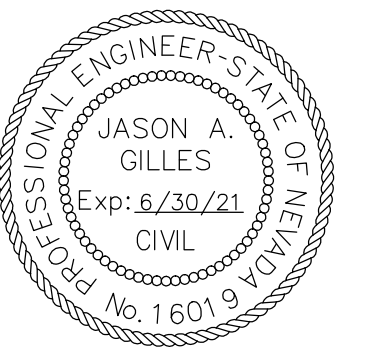

- NOTES:**
1. ADD 4500 FEET TO ALL SPOT ELEVATIONS
 2. REF. GRADING PLAN FOR CROSS-SECTION LOCATIONS.

FALCON RIDGE NORTH TENTATIVE MAP



Number	Minimum Slope	Maximum Slope	Area	% TOTAL AREA	Color
1	0%	15%	129,735	48%	Green
2	15%	20%	16,695	6%	Yellow
3	20%	25%	22,123	8%	Orange
4	25%	30%	24,250	9%	White
5	30%	>30%	76,892	29%*	Red

* PROJECT SITE HAS BEEN PREVIOUSLY DISTURBED/GRADED. TOTAL AREAS WITH A SLOPE OVER 30% NOT REPRESENTATIVE OF ORIGINAL SITE.

FALCON RIDGE NORTH TENTATIVE MAP

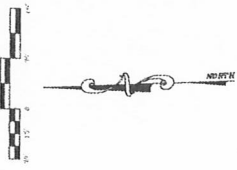

LEGEND

- PROJECT BOUNDARY
- PERMITS OF USE
- - - - - AC PROPERTY AREA
- - - - - EXISTING ROAD
- - - - - PROPOSED ROAD
- - - - - DRIVE DRIVE / UTILITY
- - - - - SANITARY SEWER
- - - - - WATER MAIN / GAS (SHOWN IN CORNER)
- - - - - SANITARY SEWER / WATER MAIN
- - - - - FIRE MAINLINE (SHOWN IN CORNER)
- - - - - FIRE MAINLINE (SHOWN IN CORNER)

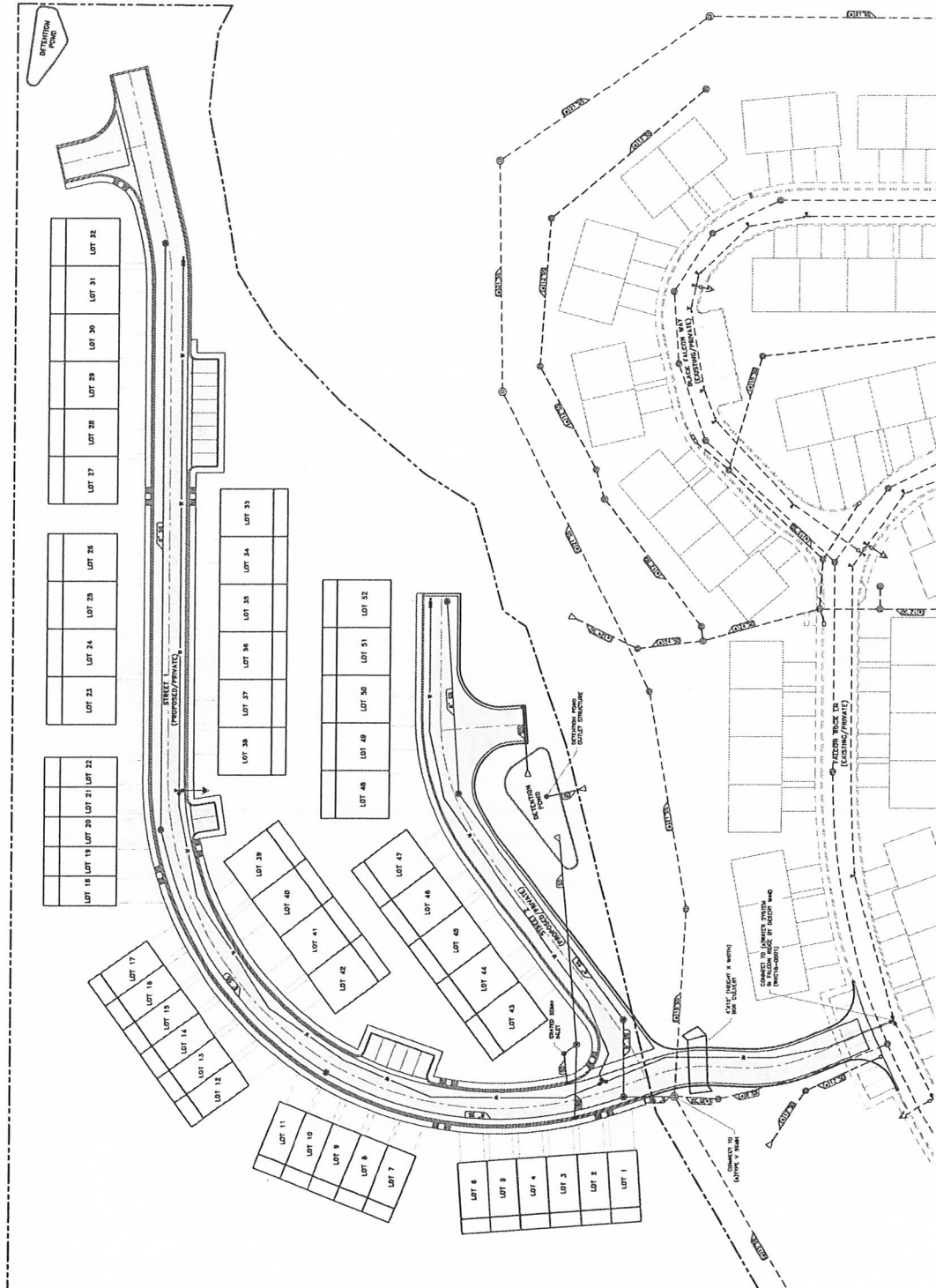

NOTES:

1. PROPOSED STORM DRAIN SYSTEM TO BE PUBLICLY OWNED AND MAINTAINED.
2. PROPOSED SANITARY SEWER SYSTEM TO BE PUBLICLY OWNED AND MAINTAINED.
3. PROPOSED WATER SYSTEM TO BE OWNED AND MAINTAINED BY THE TRUSSLE MOUND'S WATER AUTHORITY (TMA).
4. PROPOSED RETENTION POND TO BE PRIVATELY OWNED AND MAINTAINED BY THE OWNER OF THE PROPERTY.
5. DETENTION POND OUTLET STRUCTURE TO BE SIZED WITH FINAL DESIGN.



FALCON RIDGE NORTH TENTATIVE MAP

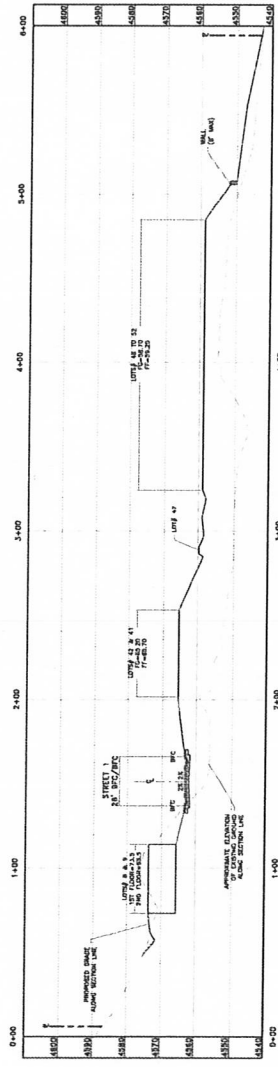
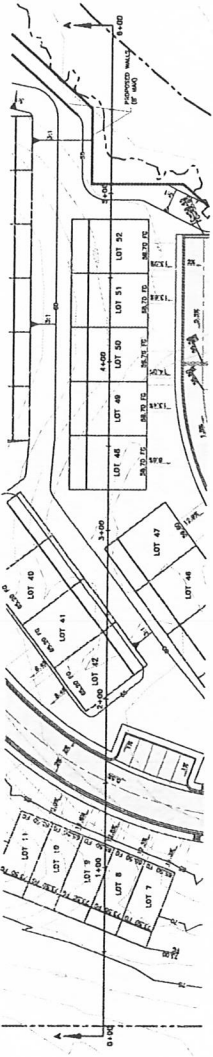

SECTION A-A

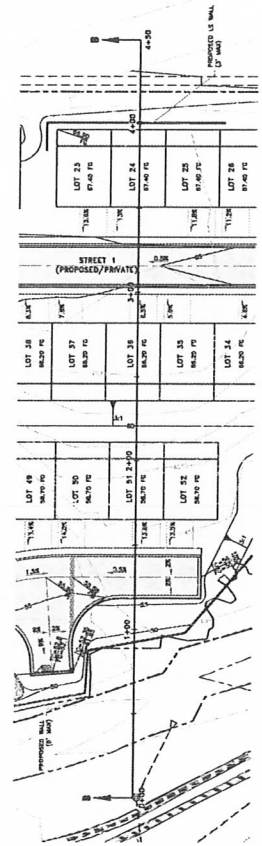

SECTION B-B

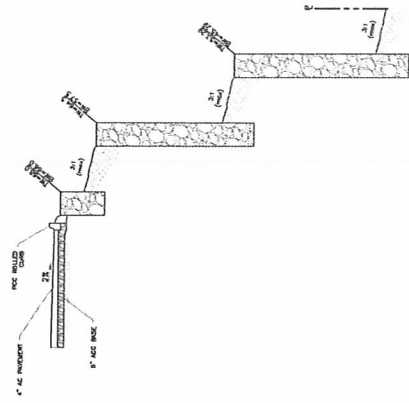
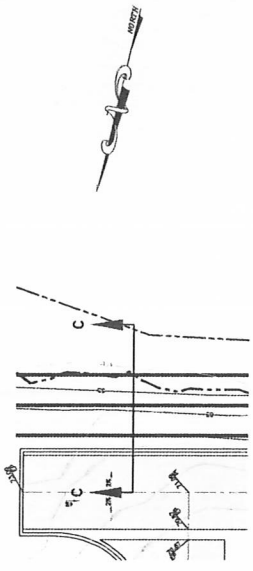

SECTION C-C
(N.I.S.)

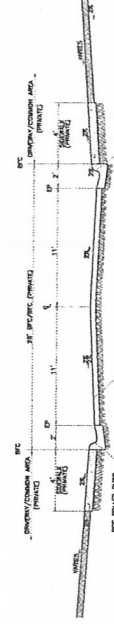

SECTION C-C
(N.I.S.)

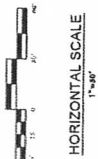

- NOTES:**
1. ADD 4000 FEET TO ALL SPOT ELEVATIONS
 2. REF. GRADING PLAN FOR CROSS-SECTION LOCATIONS.



PRELIMINARY SANITARY SEWER REPORT

TO SUPPORT THE

**FALCON RIDGE NORTH
TENTATIVE MAP**

PREPARED FOR:

**DESERT WIND, LLC
550 CALIFORNIA AVE.
RENO, NV 89509**

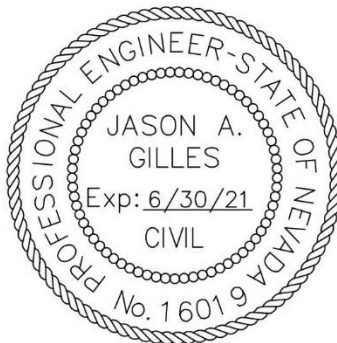

PREPARED BY:



**CIVIL
ENGINEERING
CONSULTANTS**

**JOB #: DESERTWIND.016
DATE: AUGUST 15TH, 2019**

Table of Contents

1. Introduction	1
2. Methodology.....	1
3. Existing Sanitary Sewer System.....	1
3.1. Layout.....	1
3.2. Capacity.....	1
4. Proposed Sanitary Sewer System	2
4.1. Layout.....	2
4.2. Proposed Sewage Demands	2
4.1. Capacity.....	2
5. Demand on Existing Sewer System.....	3
6. Discussion & Conclusion	3

List of Tables

Table 1: Existing Sewer Capacity.....	2
Table 2: Proposed Sewer Capacity	3
Table 3: Sewer Capacity Summary.....	3

List of Figures

Figure 1: Vicinity Map.....	APPENDIX
Figure 2: Sanitary Sewer Layout	APPENDIX

1. Introduction

This preliminary sanitary sewer analysis was prepared to support the Falcon Ridge North Tentative Map. The project is a proposed ±6.19 acre, 52-unit subdivision located in APN 035-721-02. The development is in the northeast quarter of Section 30, Township 20 North, Range 20 East, MDM (Vicinity Map – Figure 1). The project is currently zoned for LDU.

2. Methodology

Sanitary sewer flows were estimated utilizing the design criteria in Section Two of the Washoe County Engineering Design Standards. Peak flows for the mains were estimated at 270-gallons per day per residential unit with a minimum Peaking Factor of 3 (±810-gallons/day/residential unit). The Manning’s Equation was utilized with a roughness coefficient (*n*) of 0.012 for PVC pipes to determine the capacities of the sanitary sewer mains.

Manning’s Equation:

$$Q = \frac{1.49}{n} * A * R^{\frac{2}{3}} * S^{\frac{1}{2}} = Flow$$

Where:

- Q = Capacity of pipe (*cubic-feet per second*) (*cfs*)
- *n* = Manning’s runoff coefficient (*unitless*) ~ *n* = 0.012 (proposed PVC mains)
- A = Cross-sectional area (*ft²*)
- R = Hydraulic radius (*ft*)
- S = Slope (*ft/ft*)

3. Existing Sanitary Sewer System

3.1. Layout

An existing sanitary sewer trunk main is located in an existing Falcon Ridge Development in the parcel below (APN 035-721-01). This trunk main is 18-in and upsizes to a 21-in main running east. The trunk main eventually connects with infrastructure on El Rancho Drive. The existing sanitary sewer layout can be seen in the Figure 2.

3.2. Capacity

The maximum capacity of the 18-in trunk main was estimated using Manning’s Equation and characteristics found from Civil Improvement As-Builts. The trunk main has a slope of ±0.6% and is estimated to be PVC. The calculations for the main capacity are shown in Table 1.

Table 1: Existing Sewer Capacity

TABLE 1 EXISTING SEWER CAPACITY		
DIAMETER (IN)	SLOPE (%)	THEORETICAL FLOW @ 50% FULL (cfs)
18	0.6	4.02
PRELIMINARY SEWER REPORT FALCON RIDGE NORTH TENTATIVE MAP		

The maximum estimated capacity of the trunk main is 4.02-cfs at 50% full.

4. Proposed Sanitary Sewer System

4.1. Layout

The proposed sanitary sewer system will consist of 8-inch diameter mains that gravity flow along Street 1 and Street 2. The two mains will intersect at the south end of Street 1, where they will connect directly to the 18-in trunk main. All proposed sewer system will be publicly owned and maintained. All mains, with final design, will have a minimum velocity of 2.5 ft/s when flowing half full. The proposed sewer system can be seen in Figure 2 in the Appendix.

4.2. Proposed Sewage Demands

Utilizing the design criteria in Section Two of the Washoe County Engineering Design Standards, the proposed 52-unit subdivision is estimated to generate 54,600-GPD (0.084-CFS) at peak flow. The estimated peak flows are assumed to be that of single-family residential dwelling units.

The following assumptions were made:

- 52 – Single-Family Residential Units
- Average Daily Residential Rate = 270 gallons/day
- Minimum Peaking Factor (PF) ~ Per Section Two = 3
- 270 gallons/day (Residential Rate) * 3.0 (PF) = ±810 gallons/day per Residential Unit (peak flow)

Calculations:

$$52 \text{ Residential Units} * 810 \frac{\text{gpd}}{\text{Residential Unit}} = 42,120 \text{ gpd (0.065 cfs)}$$

4.1. Capacity

With the maximum combined flow of 42,120-gpd (0.065-CFS) produced from the Falcon Ridge North Development, the proposed sewer main is anticipated to handle the estimated peak flows. To calculate the main capacity, an 8-in PVC pipe with a slope of 0.5% was used to calculate the

theoretical demand to compare to the peak flow. This slope maintains a 2.5 ft/s velocity while flowing 50% full. Table 2 shows the proposed sewer capacity for an 8-in main.

Table 2: Proposed Sewer Capacity

TABLE 2 PROPOSED SEWER CAPACITY				
DIAMETER (IN)	SLOPE (%)	THEORETICAL FLOW @ 50% FULL (cfs)	ESTIMATED FLOW DEMAND (cfs)	% FULL
8	0.5	0.463	0.065	14%
PRELIMINARY SEWER REPORT FALCON RIDGE NORTH TENTATIVE MAP				

The maximum theoretical capacity of an 8-in sewer main with a minimum slope of 0.5% is 0.463-cfs. The proposed main has more than enough capacity to convey the proposed flows.

5. Demand on Existing Sewer System

With the estimated flow produced by Falcon Ridge North, and the theoretical capacity of the trunk main, the impacts on the existing system were analyzed. The total increase in the capacity of the trunk main can be seen in Table 3.

Table 3: Sewer Capacity Summary

TABLE 3 SEWER CAPACITY SUMMARY		
THEORETICAL FLOW @ 50% FULL (cfs)	PROPOSED FLOW DEMAND (cfs)	% OF TOTAL CAPACITY @ 50% FULL
4.02	0.065	2%
PRELIMINARY SEWER REPORT FALCON RIDGE NORTH TENTATIVE MAP		

With the proposed peak flows added to the trunk main, the flow increase compared to the total capacity at 50% full is estimated to be ±2%.

6. Discussion & Conclusion

The proposed system will follow the design criteria listed in Section two of the Washoe County Engineering Design Standards. The proposed development will connect directly to an existing 18-in trunk main. The existing trunk main has more than enough capacity to convey the proposed flows, with only an increase of ±2% of the maximal flow capacity at 50% full within the main. There is currently no existing infrastructure in the proposed site, and the additional flows will not

impact other facilities. As such, no adverse effects are anticipated to the adjacent or downstream sanitary sewer mains.

APPENDIX

➤ FIGURE 1: VICINITY MAP

➤ FIGURE 2: SANITARY SEWER LAYOUT

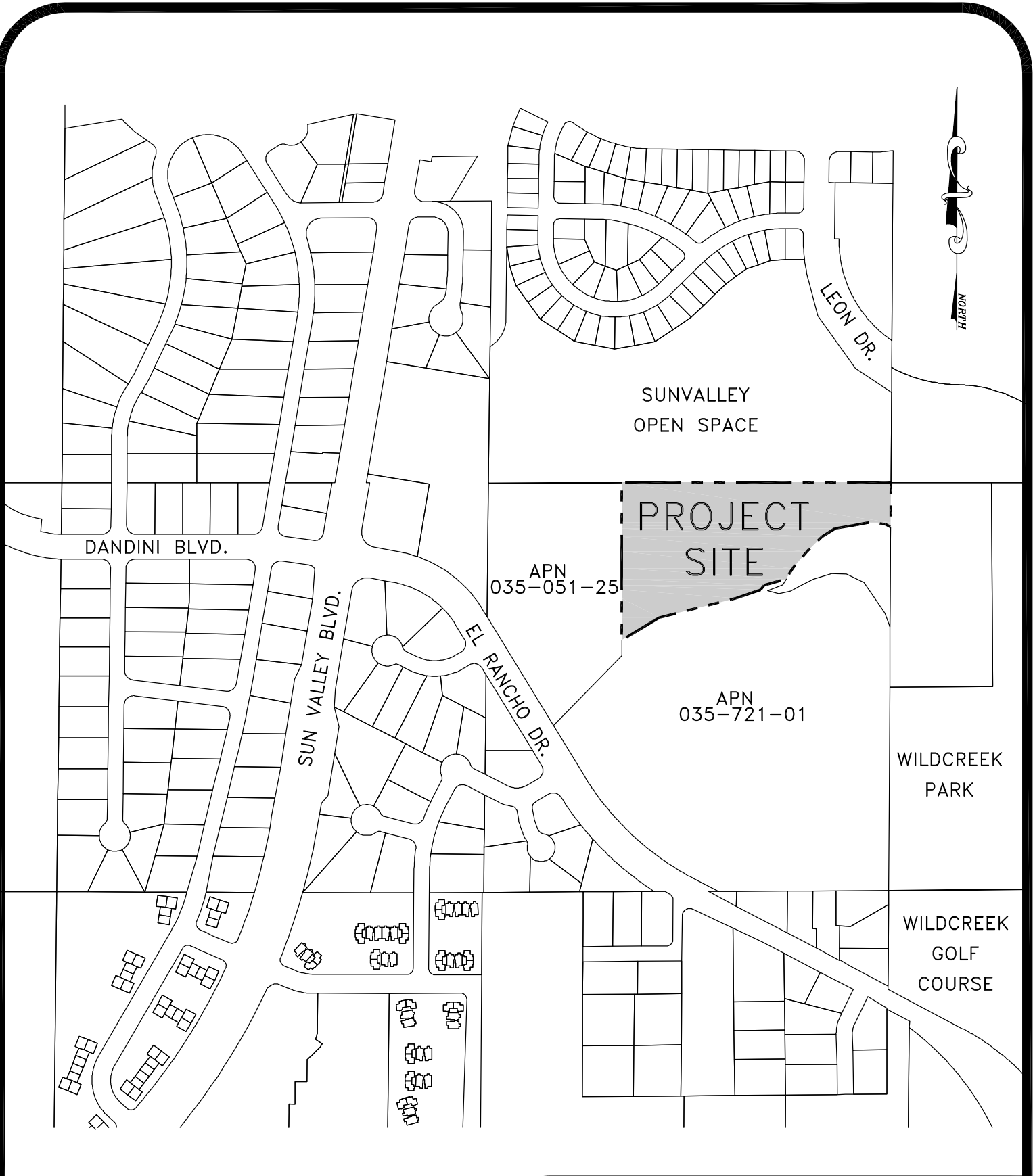

VICINITY MAP

N.T.S.

PRELIMINARY SEWER REPORT
 TO SUPPORT THE
 FALCON RIDGE NORTH
 TENTATIVE MAP

FIGURE 1

WTM19-004
 EXHIBIT

APN
035-370-01
WASHOE COUNTY
REGIONAL OPEN

APN
035-051-25
SIERRA POINT, LLC



APN
035-721-02
FALCON RIDGE NORTH
BY DESERT WIND

APN
035-051-22
CITY OF
SPARKS

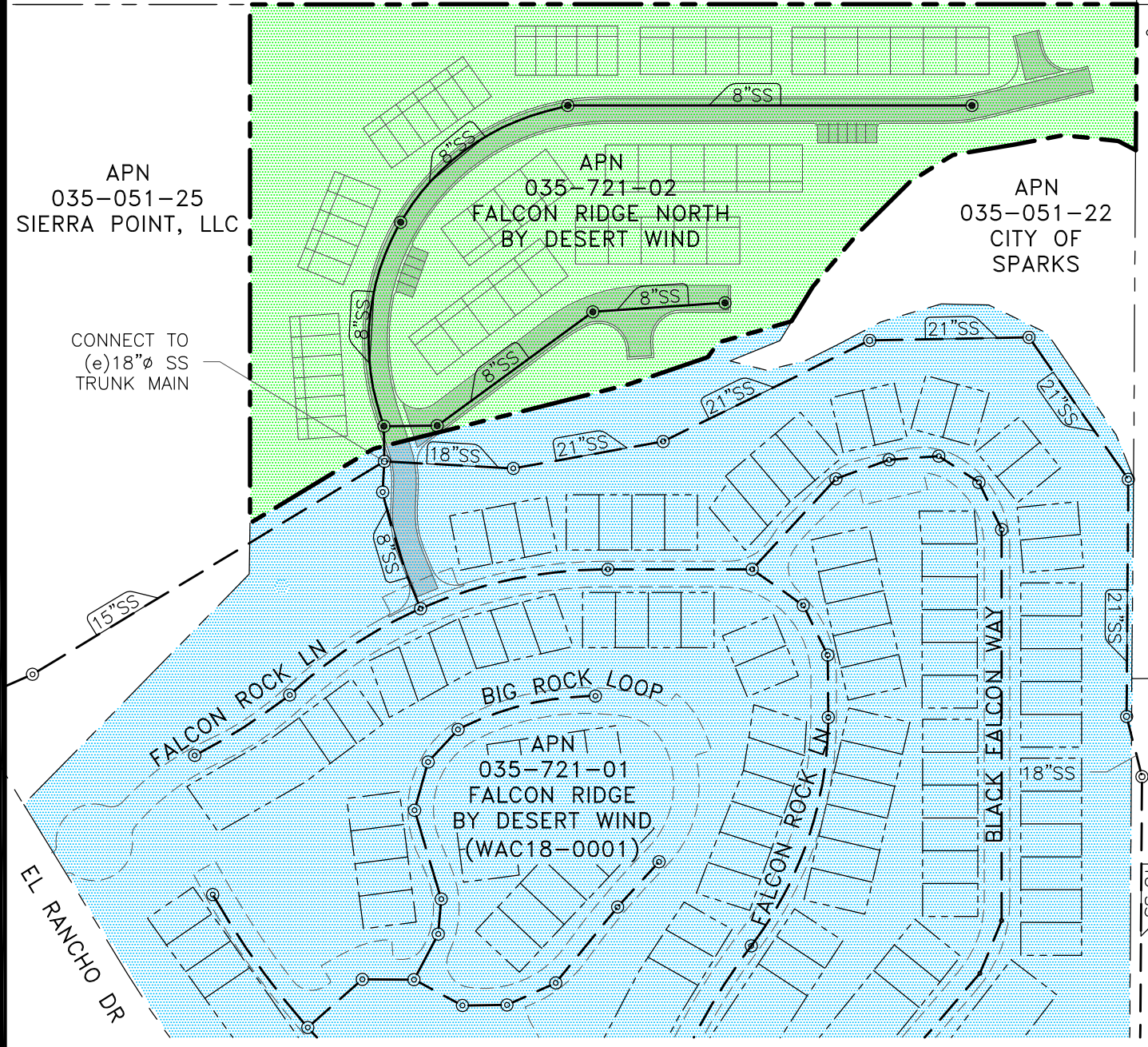
CONNECT TO
(e)18"Ø SS
TRUNK MAIN

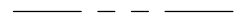
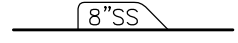

LEGEND

-  PROJECT BOUNDARY
-  EXISTING LOT LINE
-  SS MAIN w/ DIAMETER & DIRECTION
(DASHED IF EXISTING)
-  FALCON RIDGE NORTH
(52 UNITS)
-  FALCON RIDGE (WAC18-0001)
(142 UNITS)

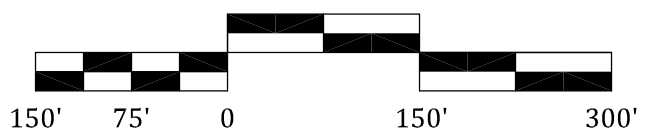

PRELIMINARY SEWER REPORT
TO SUPPORT THE
FALCON RIDGE NORTH
TENTATIVE MAP
FIGURE 2
SEWER LAYOUT

WTM19-004
EXHIBIT

PRELIMINARY HYDROLOGY REPORT

TO SUPPORT THE

**FALCON RIDGE NORTH
TENTATIVE MAP**

PREPARED FOR:

**DESERT WIND, LLC
550 CALIFORNIA AVE.
RENO, NV 89509**

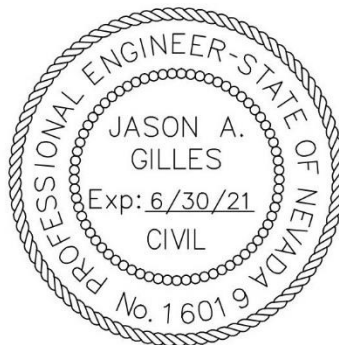

PREPARED BY:



**JOB #: DESERTWIND016
DATE: 08/15/2019**

Table of Contents

1. Introduction	1
1.1. Previous Studies	1
1.2. Flood Zone	1
1.3. Methodology	1
1.3.1. Time of Concentration (Tc)	1
2. Existing Runoff Conditions	2
2.1. Existing Runoff Patterns	2
2.2. Existing Storm Drain System	2
2.3. Calculations	2
3. Proposed Runoff Conditions	3
3.1. Proposed Runoff Patterns	3
3.2. Calculations	3
3.3. Detention Pond Volume and Discharge	3
3.3.1. Detention Pond Volume Calculations	4
4. Discussion/ Conclusions	4
5. References	5

List of Tables

Table 1: Existing Drainage Basins Hydrology	3
Table 2: Proposed Drainage Basins Hydrology	4
Table 3: Detention Summary	4

List of Figures

Figure 1: Vicinity Map	Appendix
Figure 2: Existing Drainage Basins	Appendix
Figure 3: Proposed Drainage Basins	Appendix

1. Introduction

This preliminary hydrology report was prepared to support the Falcon Ridge North Tentative Map. Falcon Ridge North is the next phase of the Falcon Ridge Townhomes development, connecting to Falcon Rock Lane. Falcon Ridge North, a proposed 52-lot subdivision, is located in the northeast quarter of Section 30, Township 20 North, Range 20 East, MDM. Reference Figure 1 in the Appendix for the Vicinity Map of the project area.

1.1. Previous Studies

A previous hydrology report was written by TEC Civil Engineering Consultants in 2017 supporting the adjacent development of the Falcon Ridge Townhomes.

1.2. Flood Zone

The project is located in the Federal Emergency Management Agency (FEMA) Flood Insurance Rate Map (FIRM) 32031C3034G. The Panel is listed in the FEMA FIRM Index Map as being partially within an Unshaded Flood Zone X, Zone X, and Zone AE according to the FEMA National Flood Insurance Program. Reference the Appendix for a copy of the FEMA FIRM Index Map.

1.3. Methodology

Due to the limited size of the contributing runoff areas, the Rational Method was utilized in determining the existing and proposed peak runoff rates. The following elements are required in utilizing the Rational Method:

$$Q = C*i*A$$

- C = Rational Method Runoff Coefficient obtained from the City of Reno Design Manual (*unitless*)
- i = Average Rainfall Intensity obtained from the National Oceanic and Atmospheric Administration (NOAA) Atlas (*inches/ hour*)
- A = Watershed area (*acres*)
- Q = Peak runoff flow (*cubic feet/second*)

Both the detention pond and outlet structure will be sized using the Rational Method during final design.

1.3.1. Time of Concentration (Tc)

A maximum time of concentration was determined by utilizing the longest drainage flow path in the particular hydrologic basin. The time of concentration was calculated using the given formula:

Ditch and gutter travel time was calculated using the following equation:

$$t_t = \frac{D}{V} \left(\frac{1}{60} \right)$$

Where:

t_t = ditch and gutter flow time (*minutes*)

D = distance of travel (*feet*)

V = velocity (*feet/second*)

Rainfall intensities were derived from the National Oceanic and Atmospheric Administration (NOAA) Atlas. Time of concentration values were calculated using the Truckee Meadows Regional Drainage Manual and the Time Travel Velocity Figure. According to Washoe County’s design standards, the minimum time of concentration to be used in calculations is 10 minutes. For basins that have a time of concentration under 10 minutes, the minimum value of 10 minutes will be substituted. The time of concentration values for basins with times of concentration over 10 minutes were utilized with their calculated value. These values were applied to the Rational Method to estimate peak flows for both the proposed development and the parcel as it exists currently. A copy of the NOAA Atlas Point Precipitation Frequency Estimate and Time Travel Velocity Figure is provided in the Appendix.

2. Existing Runoff Conditions

2.1. Existing Runoff Patterns

The proposed Falcon Ridge North site is an undeveloped 6.19-acre parcel with large amounts of desert grasses, weeds, and clay-like soil types. The site has been previously graded, and large soil stockpiles are located on-site. Runoff in this area typically sheet-flows northwest to southeast.

2.2. Existing Storm Drain System

The existing storm drain system includes a drainage channel that runs along the northern property line of the project site. This channel captures runoff from the north and northwest directions and conveys the flow easterly. There is an additional channel just south of the property line that conveys runoff easterly.

2.3. Calculations

The existing runoff rates were calculated utilizing the Rational Method. Rainfall intensities were determined to be 1.37-inches/hour and 3.44-inches/hour for the 5-year and 100-year storm events, respectively.

Table 1: Existing Drainage Basins Hydrology

AREA	RUNOFF COEFFICIENT (C)		RAINFALL INTENSITY (i)		AREA (A) (ACRES)	PEAK RUNOFF RATE (Q)=CiA (FT ³ /SEC)	
	(UNITLESS)		(INCHES/HR)			5-YEAR	100-YEAR
	5-YEAR	100-YEAR	5-YEAR	100-YEAR			
EX-1	0.40	0.50	1.37	3.44	6.19	3.39	10.65
CONTRIBUTING-1	0.40	0.50	1.37	3.44	11.18	6.13	19.23
TOTAL=					17.37	9.52	29.88
C=0.40 (5-YEAR STORM, UNDEVELOPED AREA)							
C=0.50 (100-YEAR STORM, UNDEVELOPED AREA)							

As indicated in Table 1, approximately 9.52 and 29.88-cfs of peak runoff are generated with predeveloped conditions that will be routed through the site for the 5 and 100-year storm, respectively. Reference Figure 2 in the Appendix for the existing drainage basin layout.

3. Proposed Runoff Conditions

3.1. Proposed Runoff Patterns

Storm drain pipes, catch basins, drainage swales, and curb and gutters will be utilized throughout the site to maintain proper drive-aisles and prevent flooding. The storm drain infrastructure will be publicly owned and maintained, while the detention ponds and outlet structures will be private. The storm drain system will convey runoff to the proposed detention ponds and existing drainage channel just south of the project's property line. With final design, the detention ponds and their respective outlet structures will be designed to meter flows out at existing rates. The proposed detention basins can be seen in Figure 3 provided in the Appendix.

3.2. Calculations

The proposed conditions were analyzed similarly to the existing conditions. The project site was divided into 7 proposed detention basins that utilized the same rainfall intensities as the existing conditions. The C-Values for the basins were calculated using weighted averages of impervious concrete and asphalt, rooftops, and open space area types given in the Truckee Meadows Regional Drainage Manual.

Table 2: Proposed Drainage Basins Hydrology

AREA	RUNOFF COEFFICIENT (C)		RAINFALL INTENSITY (i)		AREA (A) (ACRES)	PEAK RUNOFF RATE (Q)=CiA (FT ³ /SEC)	
	(UNITLESS)		(INCHES/HR)			5-YEAR	100-YEAR
	5-YEAR	100-YEAR	5-YEAR	100-YEAR			
PRO-1	0.70	0.75	1.37	3.44	2.95	2.83	7.61
PRO-2	0.88	0.93	1.37	3.44	0.94	1.13	3.01
PRO-3	0.88	0.93	1.37	3.44	1.25	1.51	4.00
PRO-4	0.50	0.55	1.37	3.44	1.11	0.76	2.10
PRO-5	0.85	0.90	1.37	3.44	0.05	0.06	0.15
CONTRIBUTING-1	0.40	0.50	1.37	3.44	9.28	5.09	15.96
CONTRIBUTING-2	0.40	0.50	1.37	3.44	1.90	1.04	3.27
TOTAL=					17.48	12.41	36.10
0.88 (C_{5-YEAR}) & 0.93 (C_{100-YEAR}) (APPROXIMATE VALUES FOR PAVED STREETS/ROOFING)							

As indicated in Table 2, approximately 12.41 and 36.10-cfs of peak runoff are generated onsite during the 5 and 100-year storm events, respectively. The total area of the proposed basins is larger than the existing due to the entrance roadway directing flows on-site.

3.3. Detention Pond Volume and Discharge

The excess runoff volume will be captured by the proposed detention ponds. Runoff from the site will be restricted through the use of a detention structure that will be sized with final design. The detention summary can be seen in Table 3, showing the excess runoff produced.

Table 3: Detention Summary

AREA	RUNOFF COEFFICIENT (C)		RAINFALL INTENSITY (i)		AREA (A)	PEAK RUNOFF RATE (Q)=CiA	
	(UNITLESS)		(INCHES/HR)		(ACRES)	(FT ³ /SEC)	
	5-YEAR	100-YEAR	5-YEAR	100-YEAR		5-YEAR	100-YEAR
EXISTING	0.40	0.50	1.37	3.44	17.37	9.52	29.88
PROPOSED	VARIES	VARIES	1.37	3.44	17.48	12.41	36.10
TOTAL AREA/DIFFERENCE=					17.48	2.79	5.94

As shown in Table 3 below, the increase in peak runoff rates are estimated to be 2.90 and 6.23-cfs for the 5 and 100-year storm, respectively.

Detention volume is calculated by multiplying the time of concentration by the peak flows of the proposed and existing conditions, and then finding the difference between the two. The detention volume required has been calculated to be approximately 3,564-cubic feet to capture the 100-year storm. Calculations and methodology to determine required storage volume is shown below.

3.3.1. Detention Pond Volume Calculations

100-year Required Volume Calculations:

Equation = Time of Concentration, Tc (min) * Peak Runoff Rate (cfs) * 60 sec/min

Existing = 10.00 min * 29.88 cfs * 60 sec/min = 17,928 ft³

Proposed = 10.00 min * 35.82 cfs * 60 sec/min = 21,492 ft³

Total Volume Required = 21,492 ft³ – 17,928 ft³ = 3,564 ft³

Provided Volume Calculations:

2,401 ft² (Total Detention Pond Area) * 3 ft (Average Depth/Pond) = 7,203 ft³

The initial estimations and detention pond design show that there is more than enough storage for the 100-year storm event. With final design, the detention ponds will be adequately sized and allow for metered flow that matches historical rates.

4. Discussion/ Conclusions

The proposed Falcon Ridge North project will be developed as a 52-lot subdivision. The proposed development will be graded to convey runoff primarily northwest to southeast as per existing runoff conditions. Runoff will be collected and conveyed to detention ponds that will be accurately sized to detain the increase in peak runoff volume from the 5 and 100-year storm events. The ponds will be equipped with outlets sized to restrict discharge to less than existing runoff rates. With the development of the Falcon Ridge North Development and required storm drain improvements, runoff discharge and management will be designed to remain below historic (predeveloped) flow rates and volumes. Therefore, no adverse effects are anticipated to the adjacent or downstream properties.

5. References

- *Truckee Meadows Regional Drainage Manual* dated April, 2009
- TEC Civil Engineering Consultants, Falcon Ridge Townhomes Final Hydrology Report, 2017

APPENDIX

- TRAVEL TIME VELOCITY FIGURE (FIGURE 701)
- NOAA ATLAS POINT PRECIPITATION FREQUENCY ESTIMATE
 - FEMA FIRM MAP #32031C3034G
 - FIGURE 1: VICINITY MAP
 - FIGURE 2: EXISTING DRAINAGE BASINS
 - FIGURE 3: PROPOSED DRAINAGE BASINS

Figure 15-4 Velocity versus slope for shallow concentrated flow

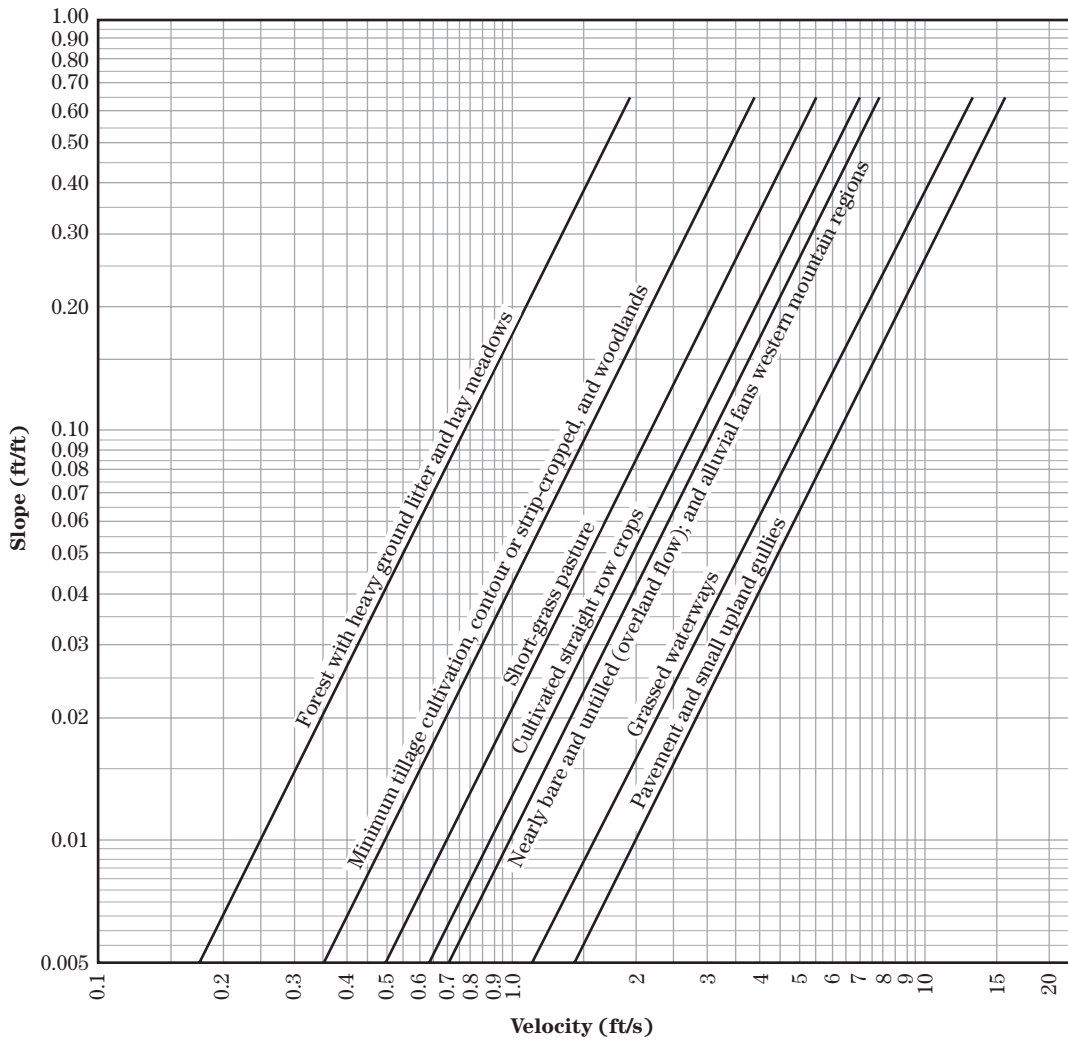

Table 15-3 Equations and assumptions developed from figure 15-4

Flow type	Depth (ft)	Manning's <i>n</i>	Velocity equation (ft/s)
Pavement and small upland gullies	0.2	0.025	$V = 20.328(s)^{0.5}$
Grassed waterways	0.4	0.050	$V = 16.135(s)^{0.5}$
Nearly bare and untilled (overland flow); and alluvial fans in western mountain regions	0.2	0.051	$V = 9.965(s)^{0.5}$
Cultivated straight row crops	0.2	0.058	$V = 8.762(s)^{0.5}$
Short-grass pasture	0.2	0.073	$V = 6.962(s)^{0.5}$
Minimum tillage cultivation, contour or strip-cropped, and woodlands	0.2	0.101	$V = 5.032(s)^{0.5}$
Forest with heavy ground litter and hay meadows	0.2	0.202	$V = 2.516(s)^{0.5}$



NOAA Atlas 14, Volume 1, Version 5
Location name: Sun Valley, Nevada, USA*
Latitude: 39.5708°, Longitude: -119.7779°
Elevation: 4572.52 ft**



* source: ESRI Maps
 ** source: USGS

POINT PRECIPITATION FREQUENCY ESTIMATES

Sanja Perica, Sarah Dietz, Sarah Heim, Lillian Hiner, Kazungu Maitaria, Deborah Martin, Sandra Pavlovic, Ishani Roy, Carl Trypaluk, Dale Unruh, Fenglin Yan, Michael Yekta, Tan Zhao, Geoffrey Bonnin, Daniel Brewer, Li-Chuan Chen, Tye Parzybok, John Yarchoan

NOAA, National Weather Service, Silver Spring, Maryland

[PF_tabular](#) | [PF_graphical](#) | [Maps_&_aerials](#)

PF tabular

PDS-based point precipitation frequency estimates with 90% confidence intervals (in inches/hour)¹										
Duration	Average recurrence interval (years)									
	1	2	5	10	25	50	100	200	500	1000
5-min	1.08 (0.912-1.24)	1.33 (1.13-1.56)	1.80 (1.52-2.11)	2.24 (1.88-2.65)	2.99 (2.46-3.59)	3.68 (2.93-4.48)	4.51 (3.48-5.57)	5.52 (4.09-6.96)	7.18 (4.99-9.35)	8.68 (5.78-11.6)
10-min	0.816 (0.696-0.942)	1.01 (0.864-1.19)	1.37 (1.16-1.61)	1.70 (1.44-2.02)	2.27 (1.87-2.73)	2.80 (2.23-3.41)	3.44 (2.65-4.24)	4.21 (3.11-5.30)	5.46 (3.80-7.12)	6.60 (4.40-8.80)
15-min	0.676 (0.576-0.780)	0.840 (0.712-0.988)	1.13 (0.960-1.34)	1.41 (1.19-1.67)	1.88 (1.55-2.26)	2.32 (1.84-2.82)	2.84 (2.19-3.50)	3.48 (2.58-4.38)	4.51 (3.14-5.88)	5.46 (3.64-7.27)
30-min	0.456 (0.388-0.526)	0.566 (0.480-0.664)	0.762 (0.646-0.898)	0.948 (0.802-1.12)	1.26 (1.04-1.52)	1.56 (1.24-1.90)	1.91 (1.48-2.36)	2.34 (1.73-2.95)	3.04 (2.12-3.96)	3.67 (2.45-4.89)
60-min	0.282 (0.240-0.325)	0.350 (0.297-0.411)	0.471 (0.400-0.556)	0.587 (0.496-0.696)	0.783 (0.644-0.939)	0.966 (0.769-1.17)	1.18 (0.913-1.46)	1.45 (1.07-1.83)	1.88 (1.31-2.45)	2.27 (1.52-3.03)
2-hr	0.188 (0.166-0.216)	0.232 (0.206-0.268)	0.298 (0.262-0.344)	0.356 (0.307-0.410)	0.445 (0.373-0.518)	0.525 (0.429-0.620)	0.617 (0.490-0.740)	0.744 (0.564-0.922)	0.970 (0.696-1.24)	1.18 (0.814-1.53)
3-hr	0.149 (0.133-0.168)	0.185 (0.167-0.210)	0.232 (0.207-0.264)	0.270 (0.239-0.307)	0.324 (0.282-0.371)	0.371 (0.316-0.430)	0.428 (0.358-0.504)	0.504 (0.411-0.620)	0.652 (0.507-0.832)	0.791 (0.592-1.03)
6-hr	0.104 (0.094-0.116)	0.130 (0.117-0.146)	0.161 (0.145-0.182)	0.185 (0.165-0.209)	0.217 (0.190-0.245)	0.240 (0.207-0.274)	0.264 (0.225-0.305)	0.293 (0.244-0.343)	0.344 (0.280-0.422)	0.401 (0.321-0.521)
12-hr	0.067 (0.061-0.075)	0.084 (0.076-0.094)	0.106 (0.095-0.118)	0.123 (0.110-0.137)	0.145 (0.128-0.164)	0.162 (0.141-0.184)	0.179 (0.153-0.207)	0.196 (0.165-0.229)	0.220 (0.179-0.262)	0.239 (0.190-0.291)
24-hr	0.042 (0.038-0.047)	0.052 (0.048-0.059)	0.067 (0.060-0.074)	0.078 (0.070-0.087)	0.094 (0.084-0.104)	0.106 (0.094-0.119)	0.119 (0.105-0.134)	0.133 (0.116-0.150)	0.152 (0.130-0.173)	0.167 (0.141-0.192)
2-day	0.025 (0.022-0.028)	0.031 (0.028-0.035)	0.040 (0.036-0.045)	0.047 (0.042-0.052)	0.057 (0.050-0.063)	0.064 (0.057-0.072)	0.072 (0.063-0.082)	0.081 (0.070-0.093)	0.093 (0.078-0.108)	0.102 (0.085-0.121)
3-day	0.018 (0.016-0.020)	0.023 (0.020-0.025)	0.029 (0.026-0.033)	0.034 (0.031-0.038)	0.042 (0.037-0.047)	0.048 (0.042-0.054)	0.054 (0.047-0.061)	0.061 (0.052-0.069)	0.070 (0.059-0.081)	0.078 (0.064-0.091)
4-day	0.014 (0.013-0.016)	0.018 (0.016-0.021)	0.024 (0.021-0.026)	0.028 (0.025-0.031)	0.034 (0.030-0.038)	0.039 (0.034-0.044)	0.045 (0.039-0.051)	0.050 (0.043-0.058)	0.059 (0.049-0.068)	0.065 (0.054-0.077)
7-day	0.010 (0.009-0.011)	0.012 (0.011-0.014)	0.016 (0.014-0.018)	0.019 (0.017-0.022)	0.023 (0.020-0.026)	0.027 (0.023-0.030)	0.030 (0.026-0.035)	0.034 (0.029-0.039)	0.039 (0.033-0.046)	0.044 (0.036-0.052)
10-day	0.008 (0.007-0.009)	0.010 (0.009-0.011)	0.013 (0.011-0.014)	0.015 (0.013-0.017)	0.018 (0.016-0.021)	0.021 (0.018-0.024)	0.023 (0.020-0.027)	0.026 (0.022-0.030)	0.030 (0.025-0.035)	0.033 (0.027-0.039)
20-day	0.005 (0.004-0.005)	0.006 (0.005-0.007)	0.008 (0.007-0.009)	0.009 (0.008-0.010)	0.011 (0.009-0.012)	0.012 (0.011-0.014)	0.014 (0.012-0.016)	0.015 (0.013-0.017)	0.017 (0.014-0.020)	0.019 (0.016-0.022)
30-day	0.003 (0.003-0.004)	0.004 (0.004-0.005)	0.006 (0.005-0.006)	0.007 (0.006-0.008)	0.008 (0.007-0.009)	0.009 (0.008-0.010)	0.010 (0.009-0.012)	0.011 (0.010-0.013)	0.013 (0.011-0.015)	0.014 (0.012-0.016)
45-day	0.003 (0.002-0.003)	0.004 (0.003-0.004)	0.005 (0.004-0.005)	0.005 (0.005-0.006)	0.006 (0.006-0.007)	0.007 (0.006-0.008)	0.008 (0.007-0.009)	0.009 (0.007-0.010)	0.010 (0.008-0.011)	0.010 (0.009-0.012)
60-day	0.002 (0.002-0.003)	0.003 (0.003-0.003)	0.004 (0.003-0.004)	0.005 (0.004-0.005)	0.005 (0.005-0.006)	0.006 (0.005-0.007)	0.006 (0.006-0.007)	0.007 (0.006-0.008)	0.008 (0.007-0.009)	0.008 (0.007-0.009)

¹ Precipitation frequency (PF) estimates in this table are based on frequency analysis of partial duration series (PDS). Numbers in parenthesis are PF estimates at lower and upper bounds of the 90% confidence interval. The probability that precipitation frequency estimates (for a given duration and average recurrence interval) will be greater than the upper bound (or less than the lower bound) is 5%. Estimates at upper bounds are not checked against probable maximum precipitation (PMP) estimates and may be higher than currently valid PMP values. Please refer to NOAA Atlas 14 document for more information.

[Back to Top](#)

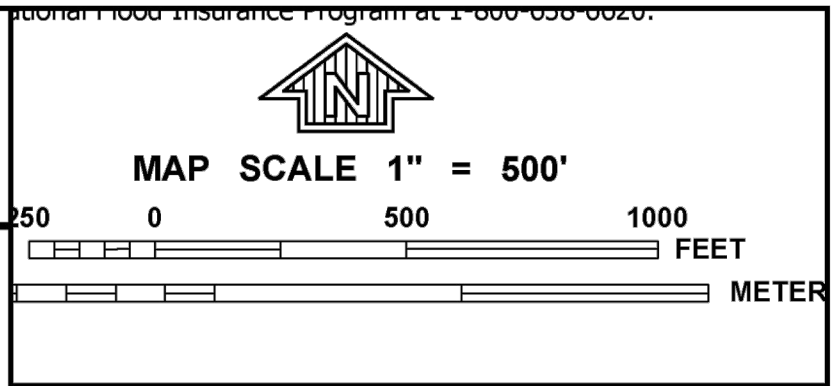
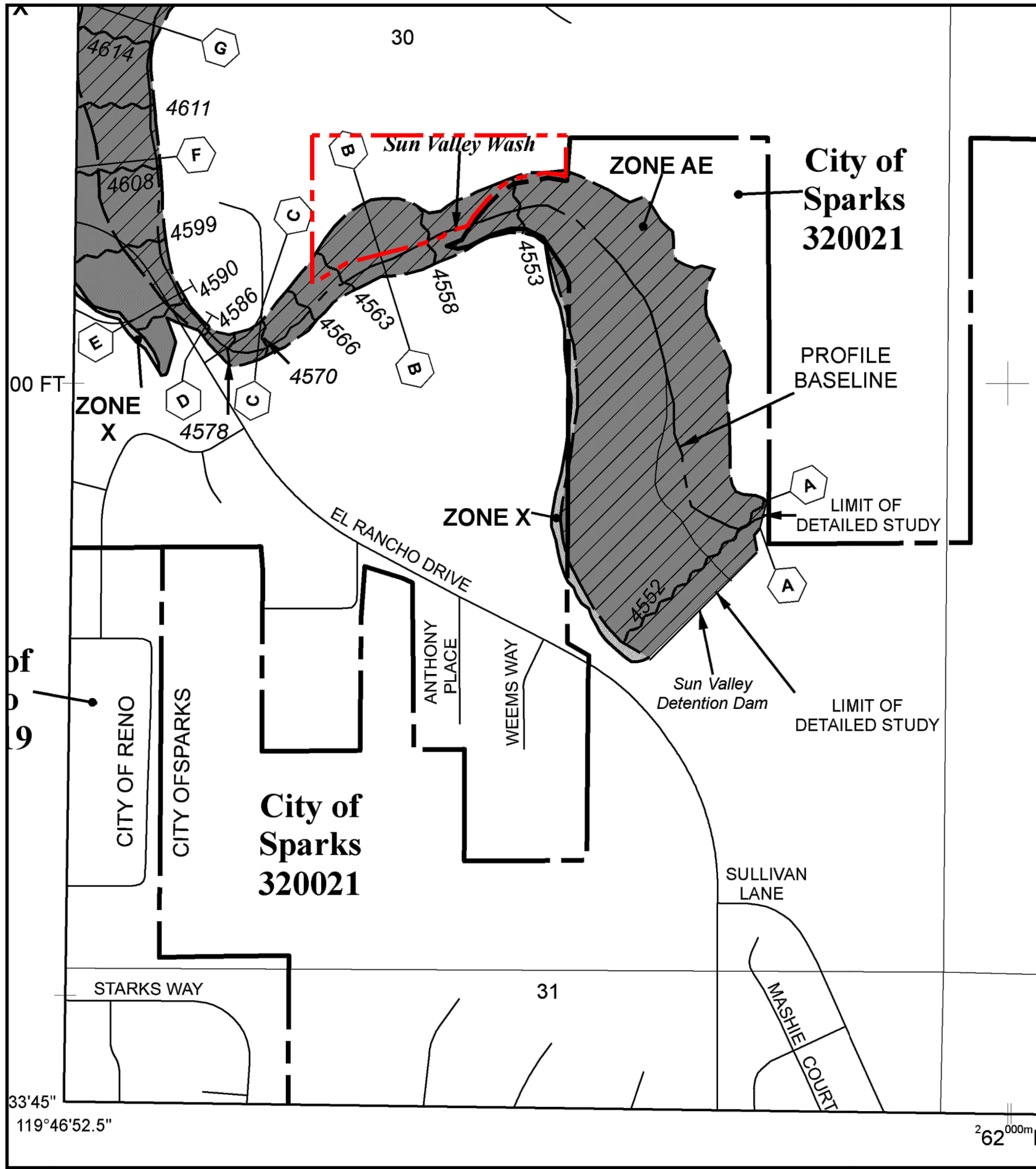

NATIONAL FLOOD INSURANCE PROGRAM

PANEL 3034G

FIRM
FLOOD INSURANCE RATE MAP

WASHOE COUNTY,
NEVADA
AND INCORPORATED AREAS

PANEL 3034 OF 3475
(SEE MAP INDEX FOR FIRM PANEL LAYOUT)

CONTAINS:

COMMUNITY	NUMBER	PANEL	SUFFIX
RENO, CITY OF	320020	3034	G
SPARKS, CITY OF	320021	3034	G
WASHOE COUNTY	320019	3034	G

Notice to User: The Map Number shown below should be used when placing map orders; the Community Number shown above should be used on insurance applications for the subject community.

MAP NUMBER
32031C3034G

MAP REVISED
MARCH 16, 2009

Federal Emergency Management Agency

33'45"
119°46'52.5"

262 000m

This is an official copy of a portion of the above referenced flood map. It was extracted using F-MIT On-Line. This map does not reflect changes or amendments which may have been made subsequent to the date on the title block. For the latest product information about National Flood Insurance Program flood maps check the FEMA Flood Map Store at www.msc.fema.gov

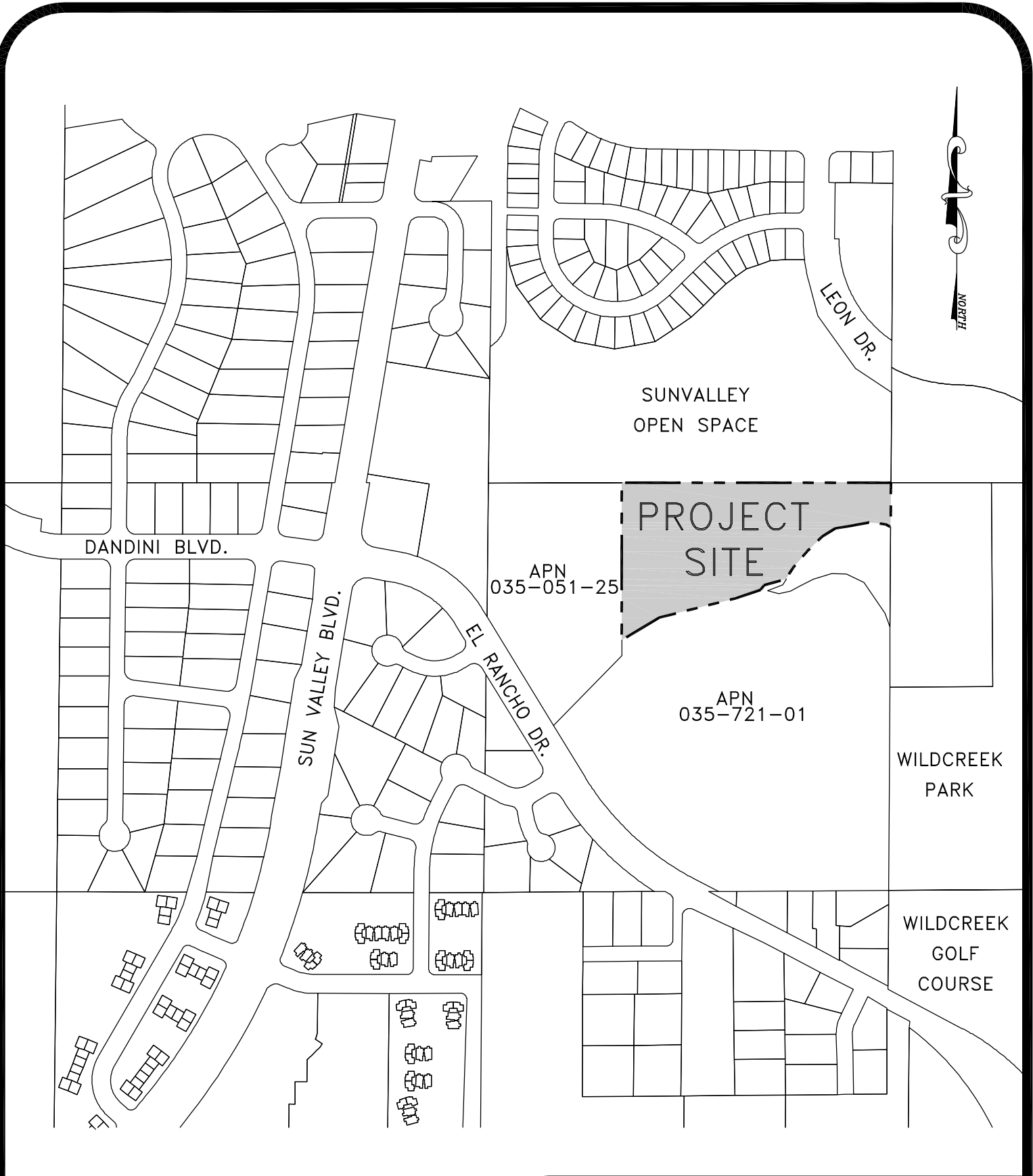

VICINITY MAP

N.T.S.

PRELIMINARY HYDROLOGY REPORT
 TO SUPPORT THE
 FALCON RIDGE NORTH
 TENTATIVE MAP

FIGURE 1

WTM19-004
 EXHIBIT

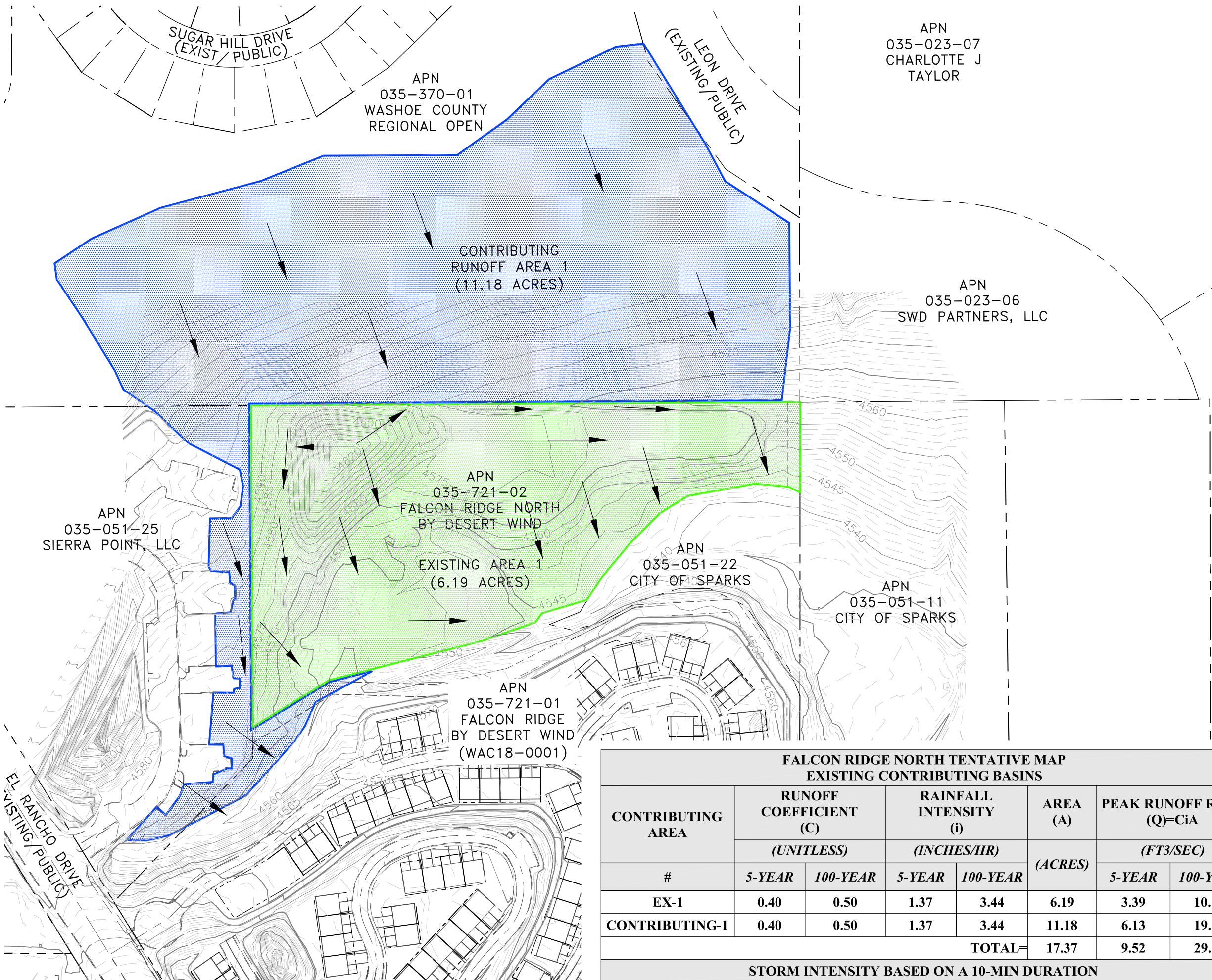

LEGEND

- PROJECT BOUNDARY
- (e)CONTOURS
- EXISTING RUNOFF DIRECTION
- EXISTING BASIN
- CONTRIBUTING RUNOFF AREA

FALCON RIDGE NORTH TENTATIVE MAP EXISTING CONTRIBUTING BASINS							
CONTRIBUTING AREA	RUNOFF COEFFICIENT (C)		RAINFALL INTENSITY (i)		AREA (A) (ACRES)	PEAK RUNOFF RATE (Q)=CiA (FT3/SEC)	
	(UNITLESS)		(INCHES/HR)			5-YEAR	100-YEAR
#	5-YEAR	100-YEAR	5-YEAR	100-YEAR		5-YEAR	100-YEAR
EX-1	0.40	0.50	1.37	3.44	6.19	3.39	10.65
CONTRIBUTING-1	0.40	0.50	1.37	3.44	11.18	6.13	19.23
TOTAL=					17.37	9.52	29.88
STORM INTENSITY BASED ON A 10-MIN DURATION							

PRELIMINARY
HYDROLOGY REPORT
TO SUPPORT THE
FALCON RIDGE NORTH
TENTATIVE MAP

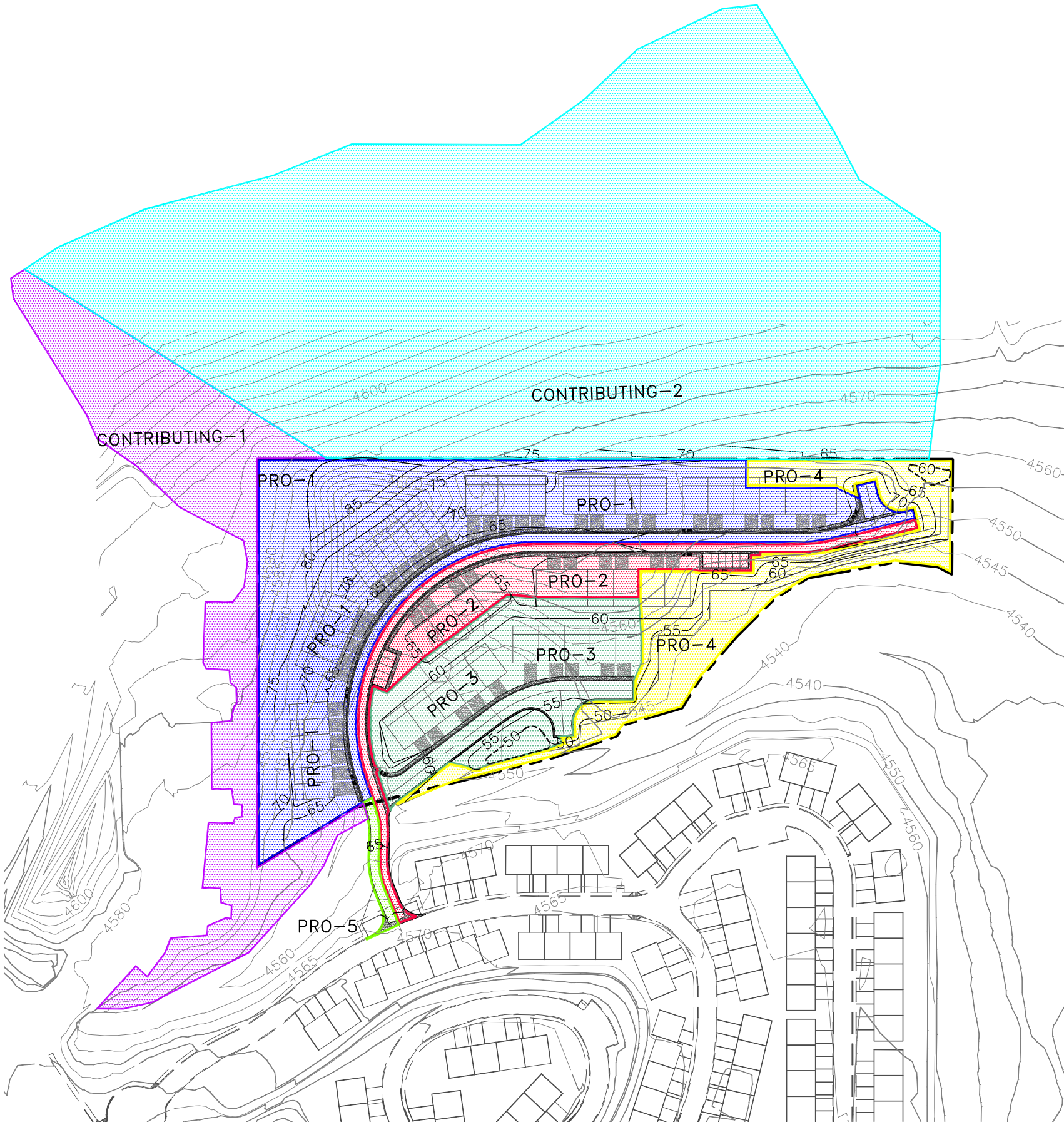
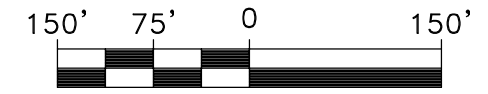

FALCON RIDGE NORTH TENTATIVE MAP PROPOSED CONTRIBUTING BASINS							
CONTRIBUTING AREA	RUNOFF COEFFICIENT (C)		RAINFALL INTENSITY (i)		AREA (A) (ACRES)	PEAK RUNOFF RATE (Q)=CiA (FT3/SEC)	
	(UNITLESS)		(INCHES/HR)			5-YEAR	100-YEAR
#	5-YEAR	100-YEAR	5-YEAR	100-YEAR		5-YEAR	100-YEAR
PRO-1	0.70	0.75	1.37	3.44	2.95	2.83	7.61
PRO-2	0.88	0.93	1.37	3.44	0.94	1.13	3.01
PRO-3	0.88	0.93	1.37	3.44	1.25	1.51	4.00
PRO-4	0.50	0.55	1.37	3.44	1.11	0.76	2.10
PRO-5	0.85	0.90	1.37	3.44	0.05	0.06	0.15
CONTRIBUTING-1	0.40	0.50	1.37	3.44	9.28	5.09	15.96
CONTRIBUTING-2	0.40	0.50	1.37	3.44	1.90	1.04	3.27
TOTAL=					17.48	12.41	36.10

LEGEND

- PROJECT BOUNDARY
- (e) CONTOURS
- PROPOSED CONTOURS
- PROPOSED BASIN
- CONTRIBUTING BASIN

PRELIMINARY
HYDROLOGY REPORT
TO SUPPORT THE
FALCON RIDGE NORTH
TENTATIVE MAP



Geotechnical & Environmental Engineers & Geologists

520 EDISON WAY • RENO, NEVADA 89502 • (775) 856-5566
FAX • (775) 856-6042
www.pezonella.com

December 27, 2005
Job No. 5334.01-N

Falcon Ridge Townhouses, LLC
401 Dayton Valley Road, Suite D
Dayton, Nevada 89403

Attention: Mr. Gary Hill

Geotechnical Engineering Services
Proposed Falcon Ridge Townhouses
El Rancho Boulevard
Washoe County, Nevada

Introduction

This report presents results of the geotechnical engineering services our firm provided for the proposed Falcon Ridge Townhouses to be located in Washoe County, Nevada. The 25.594-acre site is situated on the east side of El Rancho Boulevard, south of its intersection with Clear Acre Lane, and encompasses Washoe County Assessor's Parcel Number 035-051-26. We have not received architectural plans; however, we understand the proposed project will include construction of isolated building pads for townhouse development to be serviced by community water, sewer and storm drain systems. The structures will be 1 to 2 stories, wood framed with slab-on-grade and/or joist supported floors, and will be supported with shallow conventional spread foundations. Associated asphaltic concrete surfaced roadways and parking areas will complete project development.

We have not received structural information; however, we anticipate that foundation loads will be normal (relatively light) for the type of construction proposed, that foundations will bottom at least 24 inches below lowest exterior ground surface and that structural design will follow criteria outlined in the 2003 edition of the International Building Code.

Based on grading information prepared by Jeff Codega Planning/Design, Inc., we understand earthwork necessary to attain rough pad grades and proper site drainage will result in cuts and fills up to approximately 30 feet. Depth of utility trench excavation is unknown. We further understand that any proposed slopes will be constructed at maximum slope inclinations of two horizontal to one vertical (2:1) or flatter, that earth retaining structures are proposed, and that any underground utilities existing within proposed structural areas will be relocated.

The scope of our work is to provide site preparation and earthwork specifications for mass grading operations and public improvements. Once design parameters, such as building locations, finish floor elevations, structural loads and finish grading information has been established, a detailed geotechnical investigation report should be performed.

This report is preliminary and geotechnical in nature and not intended to identify other site constraints such as environmental hazards, wetlands determinations and/or the potential presence of buried utilities. Additionally, recommendations included in this report are specific to mass grading operations within the limits of the property and, as such, are not intended for off-site development.

To aid in our work, we reviewed the results of a preliminary geotechnical investigation dated December 14, 2004, our firm prepared in evaluation of the proposed development (Job No. 5334.01-A).

Field Exploration and Laboratory Testing

To provide an overview of the subsurface conditions, we drilled 10 test borings with truck mounted (CME 55) hollow-stem auger equipment to depths of 15 to 30 feet below the existing ground surface. The boring locations, determined in the field using pace and compass and based on the referenced civil plans, are depicted (approximate locations) on Plate 1. No greater accuracy is implied.

Our field geologist logged and visually classified the materials encountered. Relatively undisturbed samples were collected from the test borings in a split spoon sampler utilizing a 140-pound hammer with a 30-inch drop. The blows per foot required to advance the sampler were converted and recorded (Standard Penetration Test). Logs of the test borings are presented on Plates 2 through 9. The materials are classified in accordance with the Unified Soil Classification System and the Rock Classification and Weathering Criteria Chart which are explained on Plates 10 and 11, respectively.

The samples were returned to our laboratory and reviewed by our staff engineer to confirm their field classifications, to select representative samples for laboratory testing and to determine engineering design parameters. Results of "in-situ" moisture content and dry density determinations, particle size analysis, Atterberg Limits, Expansion Index, and Resistance Value determinations are presented on the logs and on Plates 12 through 18. Additional tests, Resistivity, pH and SO₄, were performed by an independent laboratory on selected samples to evaluate corrosion potential and are available on file.

Any proposed development outside the limits of our investigation or any conceptual changes to project development, such as grade changes, may require additional subsurface exploration, laboratory testing and engineering analysis.

Site, Soil and Geologic Conditions

The site is bounded by El Rancho Boulevard to the west, Sierra Point Apartments, Phase II and undeveloped land to the north, residential development to the south and undeveloped property to the east. At the time of our investigation, the property was undeveloped with the exception of a single family residence located in the northern portion of the site. The surface slopes moderately downward from the northwest to the southeast and is covered by gravel and cobbles and medium dense sagebrush and weeds with trees located along the drainage areas. Outcrops of bedrock material were evident, which create relatively high areas of relief and a drainage system containing free water traverses the site in a northwest to southeast direction.

Based on geologic mapping completed by H. F. Bonham Jr. and E. C. Bingler (Nevada Bureau of Mines and Geology, *Reno Folio*, Geologic Map, 1973), the materials underlying the site are composed of Tertiary age Alta Formation (Ta). These sediments are described as consisting of dark brown pyroxene andesite flows, flow breccia, and laharc breccia. Commonly altered to tan rock composed of quartz, sericite, and clay minerals or propylitized to gray green rock containing chlorite, calcite, albite, epidote, and clay minerals.

Based on soil mapping by the U.S. Department of Agriculture, Soil Conservation Service (*Soil Survey of Washoe County, Nevada, South Part*, Sheet No. 22, 1980), the site is underlain by the following units:

Manogue cobbly clay, 2 to 8 percent slopes (# 190): This deep to very deep, well drained soil is on uplands and is formed in localized alluvium and colluvium derived dominantly from volcanic rocks. Typically, 10 to 25 percent of the surface is covered with cobbles and pebbles. The surface layer is a dark brown, cobbly clay about 2 inches thick. The subsoil is a brown clay about 61 inches thick and weathered bedrock is at a depth of 63 inches. Depth to weathered bedrock ranges from 40 to 70 inches. Permeability is described as very slow, available water capacity is high, effective rooting depth is 40 inches or more, runoff is medium and the hazard of water erosion and soil blowing is slight. The main limitations associated with the use of this soil for urban development, as described by the Soil Conservation Service, are the high shrink-swell potential associated with the clay soils, the very slow permeable subsoil which can restrict septic tank absorption fields and for roadways, the low load-bearing strength and high clay content.

Manogue cobbly clay, 8 to 15 percent slopes (# 191): This deep and very deep, well drained soil is on uplands and is formed in localized alluvium and colluvium derived dominantly from volcanic rocks. Typically, 10 to 25 percent of the surface is covered with cobbles and pebbles. The surface layer is a dark brown, cobbly clay about 3 inches thick. The subsoil is a brown clay about 60 inches thick and weathered bedrock is at a depth of 63 inches. Depth to weathered bedrock ranges from 40 to 70 inches. Permeability is described as very slow, available water capacity is high, effective rooting depth is 40 inches or more, runoff is medium, the hazard of water erosion is slight and the hazard of soil blowing is slight. Limitations associated with the use of this unit for urban development, as described by the Soil Conservation Service, are the high shrink-swell potential associated with the high clay content, the very slowly permeable subsoil (leachfields) and the low load-bearing strength (roadways).

Reywat extremely stony loam, 15 to 30 percent slopes (# 861): This shallow, well drained soil is on uplands and is formed in residuum of basic igneous rocks. Typically, 35 to 50 percent of the surface is covered with cobbles. The surface layer is a brown, very cobbly, sandy loam about 6 inches thick. The subsoil is a brown, very gravelly, clay loam about 12 inches thick. Bedrock is at a depth of 18 inches. Depth to bedrock ranges from 10 to 20 inches. Permeability is moderately slow; available water capacity is very low; effective rooting depth is 10 to 20 inches; runoff is medium and the hazard of water erosion and soil blowing is slight. Limitations associated with the use of this unit, as described by the Soil Conservation Service, are the shallowness of soil over bedrock, which may require heavy equipment to cut through, and the soil above the bedrock is too thin to permit conventional design of absorption fields.

Reywat-Rock outcrop complex, 15 to 50 percent slopes (# 863): This moderately deep, well drained unit is on pediments and river terraces and is formed in alluvium derived from rock sources. It is described as consisting of a grayish brown, stony, sandy loam surface to about 4 inches with a subsoil of pale brown and light yellowish brown clay approximately 20 inches thick. The substratum is strongly silica-cemented hardpan about 23 inches thick over weakly consolidated sediments. Depth to hardpan ranges from 20 to 40 inches. Permeability of the unit is described as slow, available water capacity is very low, effective rooting depth is 20 to 40 inches, runoff is slow, and the hazard of water erosion and soil blowing is slight. As defined by the Soil Conservation Service, the main limitations associated with this unit regarding urban development are the high clay content and associated high shrink-swell potential and low load-bearing strength for roadways.

Our exploration confirms, in general, the soil and geologic mapping, with the native soils consisting of loose (surface) to very dense, silty and clayey sand that contains gravel; stiff to hard clay that contains sand and gravel; loose (surface) to very dense silty gravel and andesite (Alta Formation) bedrock that exhibits varying degrees of alteration and weathering. Our investigation additionally reveals that a portion (northwest area adjacent to Sierra Point Apartments, Phase II) is overlain by fill material that consists of very dense, clayey sand and gravel that contains cobbles (Test Boring No. 8).

At the time of our investigation (June 1998), free water was encountered in one of our test borings (TB 8) at a non-stabilized depth of 13 feet below the existing ground surface. Generally, stabilized levels are higher than non-stabilized and we anticipate that, seasonally, this level will fluctuate.

Our investigation reveals that the native and fill materials exist in a relatively compact and/or firm density state, exhibit low to high potential for expansion and low to moderate supporting capability. Laboratory test results conducted through an independent laboratory indicate that the native materials exhibit a severe corrosion potential to portland cement and uncoated steel or metal.

Flood Hazard studies completed by the Federal Emergency Management Agency (FEMA), Community Panel Number 32031C2984 E, effective date September 30, 1994, indicate that the majority of the proposed development is located within Flood Hazard Zone X (unshaded); however, a small percentage along the drainage way is located within Flood Hazard Zone AE. Zone X (unshaded) are areas determined, based on the National Geodetic Vertical Datum of 1929, to be outside the 500-year floodplain whereas Zone AE are special flood hazard areas inundated by 100-year flooding with a based flood elevation determined to be 4445 feet.

Based on mapping completed by E. C. Bingler (Nevada Bureau of Mines and Geology, *Reno Folio*, Earthquake Hazards Map, 1974), no known fault traces are illustrated as crossing the project site.

Conclusions

Based on the results of our geotechnical engineering services, understanding of project development, and knowledge of the areas, we conclude that, from a geotechnical engineering standpoint, the site is suitable for the intended use of the project. The primary concerns to be considered in the project design and construction are the **expansion potential** associated with the underlying materials (soil and bedrock), the presence of **bedrock**, the **steepness of slopes**, the **corrosion potential** associated with the underlying materials, the potential presence of **ground water, springs and/or seeps** and the potential for **flooding** to occur as delineated on the referenced FEMA map.

Recommendations

We have the following recommendations for design and construction during mass grading operations and public improvement:

1. To minimize potential movement within exterior flatwork and pavement areas, materials with a potential for expansion should be removed (overexcavated) a sufficient depth to provide for at least 24 inches of approved, compacted structural fill below planned subgrade.

Similarly, materials with a Resistance Value of less than 30 within 6 inches of exterior flatwork and pavement subgrade should also be removed and replaced with approved compacted structural fill material.

The amount of lateral removal (beyond all exterior edges) should be equivalent to that vertically removed.

2. The ground surface should be permanently sloped (at least ½-percent for concrete, 2-percent for pavement, and 2 to 4 percent for soil) to drain away from any improvement so that water is not allowed to pond, and to restrict infiltration within exterior flatwork and flexible pavement sections. Landscaping should be limited and irrigation should be drip-type.
3. For trust block design, we recommend the use of a bearing pressure of 1500 pounds per square foot (psf). Resistance to lateral loads can be obtained from passive earth pressures and soil friction. We recommend the use of a coefficient of friction of 0.30 and a passive pressure of 300 pounds per cubic foot per foot of depth (equivalent fluid).

As previously mentioned, the native soils exhibit corrosion potential for portland cement concrete and uncoated steel or metal. Based on these results, we believe that adequate mitigation can be attained through the use of properly prepared and placed, corrosion resistant concrete (six sack Type II portland cement concrete with 20 percent flyash admixture); by maintaining a minimum (3-inch) concrete cover where reinforcing steel or other metal is in close proximity to native soils and, at the direction of the Manufacturer, by using special coating on reinforcing steel and metal.

4. All dedicated exterior flatwork should conform to standards provided by the governing agency, including section composition, supporting material thickness and any requirements for reinforcing steel.
5. Concrete mix proportions and construction techniques, including the addition of water and improper curing, can adversely affect the finished quality of the concrete and result in cracking and spalling of the slabs. We recommend that all placement and curing be performed in accordance with procedures outlined by the Portland Cement Association and American Concrete Institute. Special consideration should be given to concrete placed and cured during hot or cold weather conditions. Proper control joints and reinforcing mesh should be provided to minimize any damage resulting from shrinkage.
6. The Earthwork Contractor must comply with the *Safety and Health Regulations for Construction* as directed by the Occupational Safety and Health Act (OSHA Standards, Volume 11, Part 1926, Subpart P) while excavating and backfilling. The Earthwork Contractor is responsible for providing a Competent Person, as defined by the OSHA standards, to ensure excavation safety.

Clayey native materials (6-inch minus) shall be use as backfill to minimize the potential for subsurface water migration through the utility trenches. Backfill materials should be moisture conditioned to near optimum and compacted to at least 90 percent relative compaction. Lift thickness shall be restricted to 8 inches (loose) maximum, unless the Contractor can demonstrate his ability to achieve the required compaction uniformly throughout the entire layer placed.

For adequate corrosion mitigation, at the direction of the Manufacturer, special coverings should be provided where uncoated steel or metal is proposed.

7. Pavement sections can gain adequate support on the previously specified minimum section of approved compacted structural fill material.

Based on our understanding of project development (142 townhouses), we believe that a minimum section consisting of 3 inches of Type 2 or 3 asphaltic concrete over 6 inches of Type 2, Class B aggregate base underlain by the previously specified minimum section of approved subbase is adequate.

In preparation for placement of the pavement section, the Earthwork Contractor shall ensure that proposed subgrade materials have been observed and/or tested by the Geotechnical Engineer (or his representative in the field) to document conformance with the Resistance Value requirements. Generally, at least the upper 6 inches of subgrade should be scarified, moisture conditioned to near optimum and compacted to at least 95 percent relative compaction. Subsequently, aggregate base materials should be placed in maximum 8-inch (loose) lifts and compacted to at least 95 percent relative compaction. All subgrades and final grades should be rolled to provide a uniform surface which is smooth, firm, and non-yielding.

Aggregates should conform to the requirements contained in the latest edition of the *Standard Specifications for Public Works Construction*.

A bituminous concrete mix design, specific for the intended use, should be submitted for approval prior to paving. During paving, the bituminous mixture should be sampled and tested by the Geotechnical Engineer to ensure material quality and compaction. Periodic crack sealing and surface sealing must be implemented to increase service life of the pavement.

8. Consideration should be given to reviewing all plans and specifications for conformance with this geotechnical report and for approval by the Geotechnical Engineer prior to submitting to the governing agencies or for bidding purposes.

The recommendations presented in this report are based on the preliminary nature of our report, and assumption that sufficient field inspection and construction review will be provided during all phases of construction. Prior to construction, a pre-job conference should be scheduled to include, but not be limited to, the Owner, Architect, Civil Engineer, General Contractor, Earthwork and Materials Sub-Contractors, Building Official and Geotechnical Engineer. The recommendations presented in this report should be reviewed by all parties to discuss applicable specifications and testing requirements. At this time, any applicable material quality and mix design reports should be submitted for approval by the Geotechnical Engineer.

Falcon Ridge Townhouses, LLC
Geotechnical Engineering Services
Proposed Falcon Ridge Townhouses
El Rancho Boulevard
Washoe County, Nevada
December 27, 2005 - Page 9

Pezonella Associates, Inc.

We should provide on-site observations and testing during site preparation and grading, excavation, fill placement and paving. These observations would allow us to document that the soil conditions are as anticipated, and that the Contractor's work is in conformance with the intent of our recommendations and the approved plans and specifications.

We appreciate having been selected to perform these services and trust that the results will fulfill project requirements at this time; however, if you, or any of your design consultants, have any questions, please contact us.

Respectfully,

PEZONELLA ASSOCIATES, INC.



12-27-05

Handwritten signature of Chris D. Betts in blue ink.

Chris D. Betts
Engineer Geologist

Handwritten signature of Raymond M. Pezonella in blue ink.

Raymond M. Pezonella
Civil Engineer - 4186

Enclosures: Plate 1 through 19
Specifications for Site Preparation and Earthwork

Submittal: Original and two copies

cc: Jeff Codega Planning/Design, Inc. (Attention: Mr. Tom Tescher, PE)

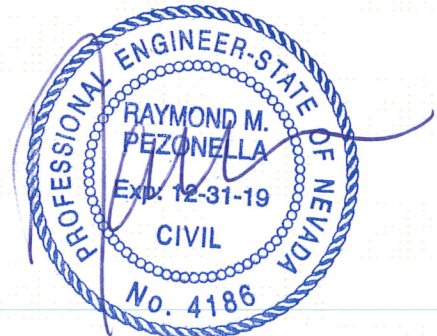

8-9-19

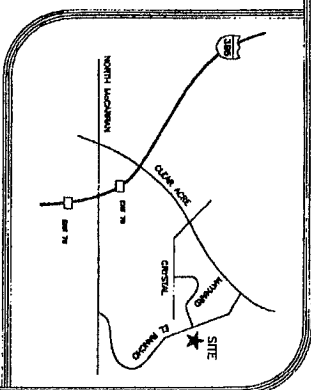

VICINITY MAP

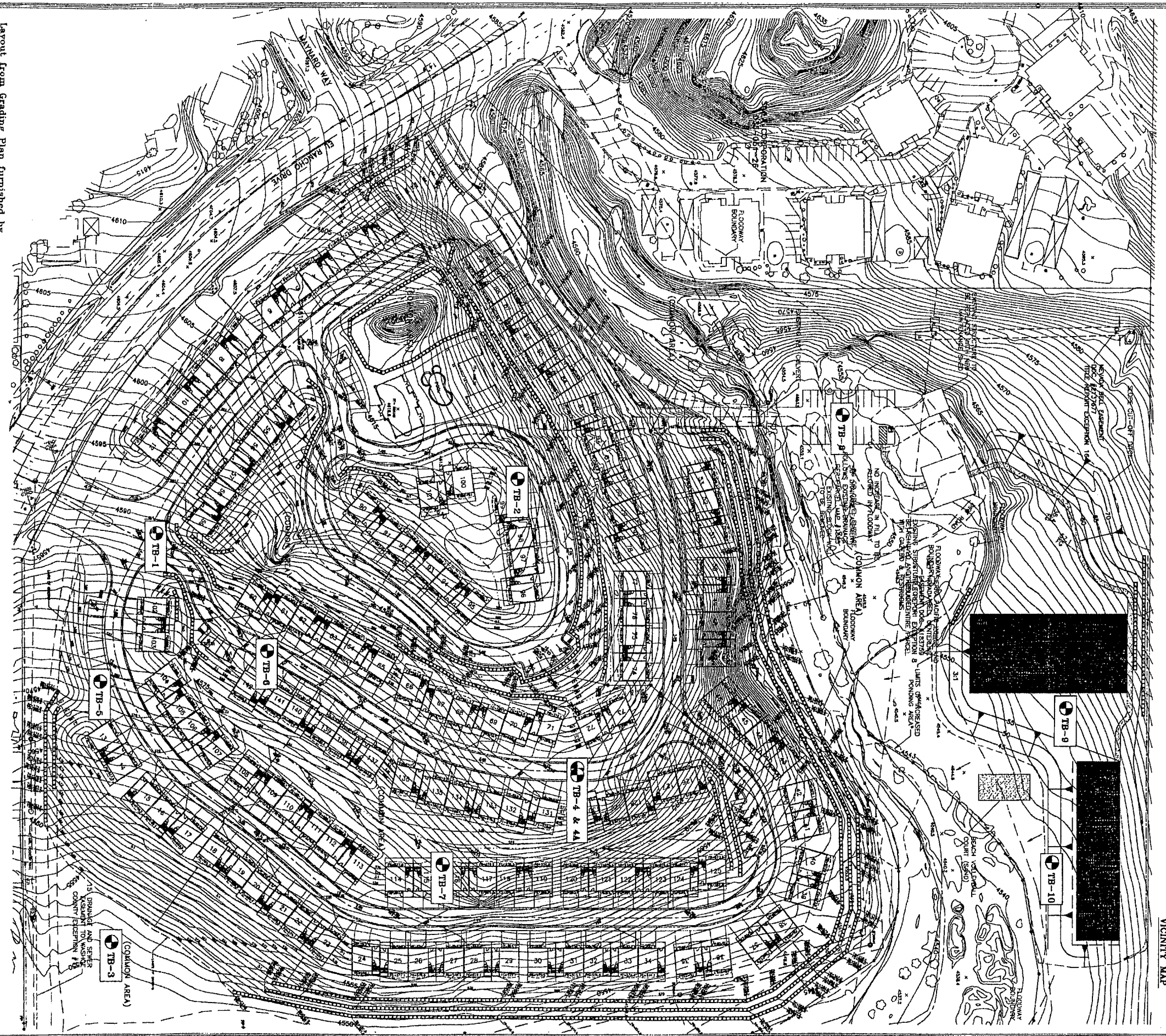

Layout from Grading Plan furnished by
Jeff Codega Planning and Design, Inc.

● = Boring Location

RTS	1	2	3	4
5934.01-N	1	2	3	4
12-28-05	1	2	3	4
NOT TO SCALE	1	2	3	4

PLAT

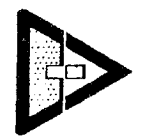

Pezonella
Associates, Inc

Consulting Engineers
520 Edison Way Reno, Nevada 89502
PHONE (775) 856-5566 FAX (775) 856-6042

FALCON RIDGE
TOWNHOUSES
WASHOE COUNTY, NEVADA

LOG OF BORING 1

Equipment CME 55 Hollow Stem Auger

Elevation 4588 Date 06-04-98

Laboratory Tests and (Other Information)	Driving Resistance Blows/Ft.	Moisture Content (%)	Dry Density (pcf)	Depth (ft) Sample	
* Plasticity Chart (See Plate 14) Expansion Index (See Plate 17)	9			*	BROWN CLAYEY SAND (SC) with gravel loose, dry with roots
	20			**	BROWN SANDY CLAY (CH) with gravel stiff, moist
** Plasticity Chart (See Plate 15)		24.7	89	5	BROWN-YELLOW ANDESITE (Alta Formation) moderately fractured, moderately hard, moderately strong and moderately weathered
	37			10	
	66			15	sampler refusal at 15.0 feet
	50/5"				No Free Water Encountered

Elevation Reference:

Elevations taken from topographical information
provided by Jeff Codega, Planning/Design, Inc.

Job No. 5334.01-N	BORING LOG	COB/appr./12-28-05
 Pezonella Associates, Inc Consulting Engineers 520 Edison Way Reno, Nevada 89502 PHONE (775) 856-6666 FAX (775) 856-6042	FALCON RIDGE TOWNHOUSES WASHOE COUNTY, NEVADA	Plate No. 2

LOG OF BORING 2

Equipment CME 55 Hollow Stem Auger

Elevation 4609 Date 06-04-98

Laboratory Tests and (Other Information)	Driving Resistance Blows/Ft.	Moisture Content (%)	Dry Density (pcf)	Depth (ft) Sample	
* Particle Size Distribution Report with Atterberg Limits (See Plate 12)	49			0	BROWN SILTY SAND (SM) medium dense, dry with roots
	74			5	BROWN TO WHITE ANDESITE (Alta Formation) moderately fractured, moderately hard, moderately strong and moderately weathered sampler refusal at 4.0 feet
	60/6"			10	sampler refusal at 9.0 feet
	59/6"			15	sampler refusal at 13.5 feet
	50/4"			20	sampler refusal at 19.0 feet
	50/5"			25	sampler refusal at 24.0 feet
	50/4"			30	sampler refusal at 29.5 feet

No Free Water Encountered

Elevation Reference:

See log of Boring 1

Job No. 5334.01-N	BORING LOG	CMB /appr./12-28-05
 Pezonella Associates, Inc Consulting Engineers 520 Edison Way Reno, Nevada 89502 PHONE (775) 856-5568 FAX (775) 856-8042	FALCON RIDGE TOWNHOUSES WASHOE COUNTY, NEVADA	Plate No. 3

LOG OF BORING 3

Equipment CME 55 Hollow Stem Auger

Elevation 4552 Date 06-04-98

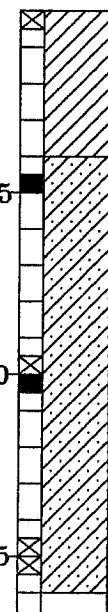
Laboratory Tests and (Other Information)	Driving Resistance Blows/Ft.	Moisture Content (%)	Dry Density (pcf)	Depth (ft) Sample		
* Plasticity Chart (See Plate 16)	9	14.9	115	0		
	20			5		BROWN CLAY (CH) with sand hard, dry with roots to 1.0 feet
	37			10		BROWN CLAYEY SAND (SC) with gravel dense, dry
	66			15		becoming medlum dense, moist and increasing clay content below 14.5 feet
	50/5"					No Free Water Encountered

Elevation Reference:

See Log Of Boring 1

Job No. 5334.01-N

BORING LOG

COB/appr./12-28-05

 **Pezonella
Associates, Inc**
Consulting Engineers
520 Edison Way Reno, Nevada 89502
PHONE (775) 856-6566 FAX (775) 856-6042

FALCON RIDGE TOWNHOUSES
WASHOE COUNTY, NEVADA

Plate No. 4

**WTM19-004
EXHIBIT F**

LOG OF BORING 4

Equipment CME 55 Hollow Stem Auger

Elevation 4592 Date 06-04-98

Laboratory Tests and (Other Information)	Driving Resistance Blows/Ft.	Moisture Content (%)	Dry Density (pcf)	Depth (ft) Sample	
	43			0	<p>BROWN SILTY SAND (SM) medium dense, dry with roots BROWN CLAY (CH) with gravel very stiff, dry with roots</p>
	27/3"			5	<p>ORANGE ANDESITE (Alta Formation) moderately fractured, moderately hard, moderately strong and moderately weathered sampler refusal at 4.0 feet</p>
	50/2"			10	<p>sampler refusal at 9.0 feet</p>
	50/2"			15	<p>sampler refusal at 14.0 feet</p>
	25/0"			20	<p>sampler refusal at 19.0 feet</p> <p style="text-align: center;">No Free Water Encountered</p>

Elevation Reference:

See Log Of Boring 1

Job No. 5334.01-N

BORING LOG

CMB /appr./12-28-05

 **Pezonella Associates, Inc**

Consulting Engineers
 520 Edison Way Reno, Nevada 89502
 PHONE (775) 856-5566 FAX (775) 856-5042

FALCON RIDGE TOWNHOUSES
WASHOE COUNTY, NEVADA

Plate No. 5

WTM19-004
EXHIBIT F

LOG OF BORING 4A

Equipment CME 55 Hollow Stem Auger

Elevation 4592 Date 06-05-98

Laboratory Tests and (Other Information)	Driving Resistance Blows/Ft.	Moisture Content (%)	Dry Density (pcf)	Depth (ft) Sample	
	43				<p style="margin-top: 10px;">BROWN SILTY GRAVEL (GM) dense, dry</p> <p style="margin-top: 10px;">becoming very dense below 3.0 feet</p> <p style="margin-top: 10px;">ORANGE ANDESITE (Alta Formation) moderately fractured, moderately hard, moderately strong and moderately weathered</p> <p style="margin-top: 10px;">No Free Water Encountered</p>
	27/3"			5	
	50/2"			10	
	50/2"			15	
	25/0"			20	
				25	

Elevation Reference:

See Log Of Boring 1

Job No. 5334.01-N	BORING LOG	CDB /appr./12-28-05
Pezonella Associates, Inc <small>Consulting Engineers 520 Edison Way Reno, Nevada 89502 PHONE (775) 856-5566 FAX (775) 856-6042</small>	FALCON RIDGE TOWNHOUSES WASHOE COUNTY, NEVADA	Plate No. 6

LOG OF BORING 5

Equipment CME 55 Hollow Stem Auger

Elevation 4572 Date 06-05-98

Laboratory Tests and (Other Information)	Driving Resistance Blows/Ft.	Moisture Content (%)	Dry Density (pcf)
	17		
	27/5"		
	50/3"		
	36		

Depth (ft)
Sample

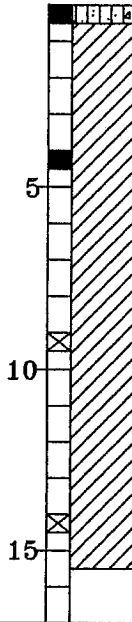

BROWN SILTY GRAVEL (GM) loose, dry with roots
BROWN CLAY (CH) hard, dry

color change to orange-brown below 4.0 feet
sampler refusal at 4.0 feet

with gravel below 9.0 feet
sampler refusal at 9.0 feet

No Free Water Encountered

Elevation Reference:

See Log Of Boring 1

LOG OF BORING 6

Equipment CME 55 Hollow Stem Auger

Elevation 4582 Date 06-17-98

	11		
	23		
	43		
	63		
	37		

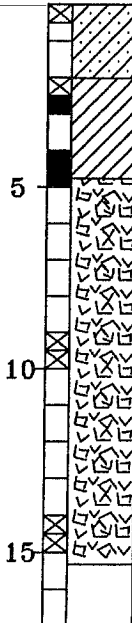

DARK BROWN CLAYEY SAND (SC) with gravel
medium dense, moist with roots

ORANGE-BROWN CLAY (CH) with gravel
very stiff, moist

BROWN-YELLOW ANDESITE (Alta Formation) moderately
fractured, moderately hard, moderately strong and
moderately weathered

with gravel and becoming dense below 13.0 feet

No Free Water Encountered

Elevation Reference:

See Log Of Boring 1

Job No. 5334.01-N

BORING LOG

CDB/appr./12-28-05

Pezonella Associates, Inc
Consulting Engineers
520 Edison Way Reno, Nevada 89502
PHONE (775) 856-5566 FAX (775) 856-6048

FALCON RIDGE TOWNHOUSES
WASHOE COUNTY, NEVADA

Plate No. 7

WTM19-004
EXHIBIT F

LOG OF BORING 7

Equipment CME 55 Hollow Stem Auger

Elevation 4574 Date 06-17-98

Laboratory Tests and (Other Information)	Driving Resistance Blows/Ft.	Moisture Content (%)	Dry Density (pcf)	Depth (ft) Sample	
	21			0	DARK BROWN CLAYEY SAND (SC) with gravel medium dense, moist with roots to 1.0 feet
	19			5	BROWN CLAY (CH) with sand and gravel stiff, moist
	33			10	Increasing sand content below 9.0 feet
	77			15	ORANGE ANDESITE (Alta Formation) moderately fractured, moderately hard, moderately strong and moderately weathered
					No Free Water Encountered

Elevation Reference:

See Log Of Boring 1

LOG OF BORING 8

Equipment CME 55 Hollow Stem Auger

Elevation 4559 Date 06-17-98

Laboratory Tests and (Other Information)	Driving Resistance Blows/Ft.	Moisture Content (%)	Dry Density (pcf)	Depth (ft) Sample	
* Particle Size Distribution Report with Atterberg Limits (See Plate 13) R-Value Test Report (See Plate 18)	27/6"			0	BROWN CLAYEY SAND (SC) with gravel very dense, moist with roots to 1.0 feet sampler refusal at 0.5 feet color change to dark brown below 1.0 feet
	30/6"			5	sampler refusal at 3.5 feet BROWN CLAYEY GRAVEL (GC) with sand and cobbles very dense, wet
	30/4"			10	ORANGE-BROWN CLAYEY SAND (SC) with gravel very dense, moist sampler refusal at 8.5 feet
	24			15	water level (13.0 feet). Not stabilized 06-17-98 color change to light tan and becoming medium dense and saturated below 13.0 feet No Free Water Encountered
					FILL

Elevation Reference:

See Log Of Boring 1

Job No. 5334.01-N	BORING LOG	CMB /appr./12-28-05
 Pezonella Associates, Inc Consulting Engineers 520 Edison Way Reno, Nevada 89502 PHONE (775) 856-5666 FAX (775) 856-6042	FALCON RIDGE TOWNHOUSES WASHOE COUNTY, NEVADA	Plate No. 8

LOG OF BORING 9

Equipment CME 55 Hollow Stem Auger

Elevation 4554 Date 06-17-98

Laboratory Tests and (Other Information)	Driving Resistance Blows/Ft.	Moisture Content (%)	Dry Density (pcf)	Depth (ft) Sample
	35			
	10 23			
	29			
	14			

BROWN SANDY CLAY (CH)
stiff, dry with roots to 1.0 feet

LIGHT BROWN SILTY SAND (SM)
medium dense, dry

ORANGE ANDESITE (Alta Formation) moderately fractured, moderately hard, moderately strong and moderately weathered

No Free Water Encountered

Elevation Reference:

See Log Of Boring 1

LOG OF BORING 10

Equipment CME 55 Hollow Stem Auger

Elevation 4548 Date 06-17-98

	19			
	27/5"			
	67/6"			
	79			

BROWN SILTY SAND (SM) loose, dry
BROWN SANDY CLAY (CH) very stiff, moist
ORANGE-BROWN CLAYEY SAND (SC) very dense, moist

sampler refusal at 4.5 feet

sampler refusal at 9.5 feet

No Free Water Encountered

Elevation Reference:

See Log Of Boring 1

Job No. 5334.01-N	BORING LOG	CSB/appr./12-28-05
Pezonella Associates, Inc Consulting Engineers 520 Edison Way Reno, Nevada 89502 PHONE (775) 856-5566 FAX (775) 856-6042	FALCON RIDGE TOWNHOUSES WASHOE COUNTY, NEVADA	Plate No. 9

MAJOR DIVISIONS		TYPICAL NAMES	
COARSE GRAINED SOILS MORE THAN HALF IS LARGER THAN #200 SIEVE	GRAVELS MORE THAN HALF COURSE FRACTION IS LARGER THAN No. 4 SIEVE SIZE	CLEAN GRAVELS WITH LITTLE OR NO FINES	GW WELL GRADED GRAVELS, GRAVEL-SAND MIXTURES
			GP POORLY GRADED GRAVELS, GRAVEL-SAND MIXTURES
		GRAVELS WITH OVER 12% FINES	GM SILTY GRAVELS, POORLY GRADED GRAVEL-SAND SILT MIXTURES
			GC CLAYEY GRAVELS, POORLY GRADED GRAVEL-SAND-CLAY MIXTURES
	SANDS MORE THAN HALF COURSE FRACTION IS SMALLER THAN No. 4 SIEVE SIZE	CLEAN SANDS WITH LITTLE OR NO FINES	SW WELL GRADED SANDS, GRAVELLY SANDS
			SP POORLY GRADED SANDS, GRAVELLY SANDS
		SANDS WITH OVER 12% FINES	SM SILTY SANDS, POORLY GRADED SAND-SILT MIXTURES
			SC CLAYEY SANDS, POORLY GRADED SAND-CLAY MIXTURES
FINE GRAINED SOILS MORE THAN HALF IS SMALLER THAN #200 SIEVE	SILTS AND CLAY LIQUID LIMIT LESS THAN 50	ML INORGANIC SILTS AND VERY FINE SANDS, ROCK FLOUR, SILTY OR CLAYEY FINE SANDS OR CLAYEY SILTS WITH SLIGHT PLASTICITY	
		CL INORGANIC CLAYS OF LOW TO MEDIUM PLASTICITY, GRAVELLY CLAYS, SANDY CLAYS SILTY CLAYS, LEAN CLAYS	
		OL INORGANIC CLAYS AND ORGANIC SILTY CLAYS OF LOW PLASTICITY	
	SILTS AND CLAYS LIQUID LIMIT GREATER THAN 50	MH INORGANIC SILTS, MICACEOUS OR DIATOMACEOUS FINE SANDY OR SILTY SOILS, ELASTIC SILTS	
		CH INORGANIC CLAYS OF HIGH PLASTICITY, FAT CLAYS	
		OH ORGANIC CLAYS OF MEDIUM TO HIGH PLASTICITY, ORGANIC SILTS	
BEDROCK		ANDESITE BEDROCK (ALTA FORMATION)	

UNIFIED SOIL CLASSIFICATION SYSTEM

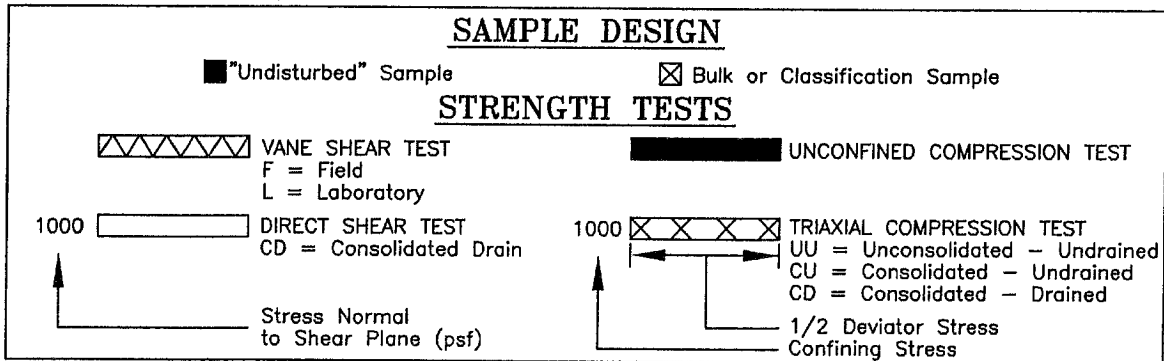

KEY TO TEST DATA

Job No. 5334.01-N

FALCON RIDGE TOWNHOUSES /appr./12-28-05

Pezonella Associates, Inc
 Consulting Engineers
 520 Edison Way Reno, Nevada 89502
 PHONE (775) 866-6666 FAX (775) 866-8042

**SOIL CLASSIFICATION CHART
 AND KEY TO TEST DATA**

Plate No. 10

WTM19-004
 EXHIBIT F

FRACTURING - Fractures include joints, faults and shears. Joints are fractures (no relative movement of rock on either side) and can be regular or irregular and discontinuous. Faults or shears are fractures on which movement has taken place.

Intensity	Fracture Spacing (ft)
Crushed	Less than 0.05
Intensely fractured	0.05 - 0.1
Closely fractured	0.1 - 0.5
Moderately fractured	0.5 - 1.0
Little fractured	1.0 - 4.0
Massive	Greater than 4.0

HARDNESS - Hardness and strength are in many ways interrelated and the meaning of the term depends on the use to which it is put. Hardness is evaluated with a pocket knife on an unfractured specimen. When equating mass hardness, the degree of fracturing should always be considered.

- A. Soft - reserved for plastic material only
- B. Low Hardness - can be gouged deeply or carved with a pocket knife
- C. Moderately Hard - can be readily scratched by a knife blade, scratch leaves heavy traces of dust and is readily visible after the powder has been blown away.
- D. Hard - can be scratched with difficulty, scratch produces little powder and is often faintly visible.
- E. Very Hard - cannot be scratched with pocket knife, leaves metallic streak.

STRENGTH - The strength of rock visually evaluated in the field is somewhat subjective in that it depends upon the observer's interpretation and of the response of unfractured specimens to hammer blows. Consistency between observers can be evaluated through laboratory test results.

- A. Plastic - material deforms with hammer blows without fracturing
- B. Friable - crumbles by rubbing with fingers.
- C. Moderately Strong - specimen will withstand few heavy hammer blows before breaking.
- D. Strong - Specimen will withstand a few heavy ringing hammer blows and usually yields large fragments.
- E. Very Strong - Rock will resist heavy ringing hammer blows and will yield with difficulty only dust and small flying fragments.

WEATHERING -	DEEP	MODERATE	LITTLE	FRESH
DECOMPOSITION	moderate to complete	affects only slight change in minerals	no megascopic decomposition of minerals	unaffected by weathering agents
DISCOLORATION	deep and thorough	moderate or localized and intense	slight and intermittent or localized	unaffected by weathering agents
FRACTURE CONDITION Minerals Present	all fractures extensively coated with oxides, carbonates, or clay or silt	moderately coated	few stains on fracture surfaces	unaffected by weathering agents

NOTE: The physical and chemical disintegration and decomposition of rocks and minerals by natural processes such as oxidation reduction, hydration, solution, carbonation, and freezing and thawing.

Job No. 5334.01-N

**ROCK AND WEATHERING
CLASSIFICATION CRITERIA**

CSB /appr./12-28-05

 **Pezonella
Associates, Inc**
Consulting Engineers
520 Edison Way Reno, Nevada 89502
PHONE (775) 856-5566 FAX (775) 856-5042

**FALCON RIDGE TOWNHOUSES
WASHOE COUNTY, NEVADA**

Plate No. 11

**WTM19-004
EXHIBIT F**

Particle Size Distribution Report

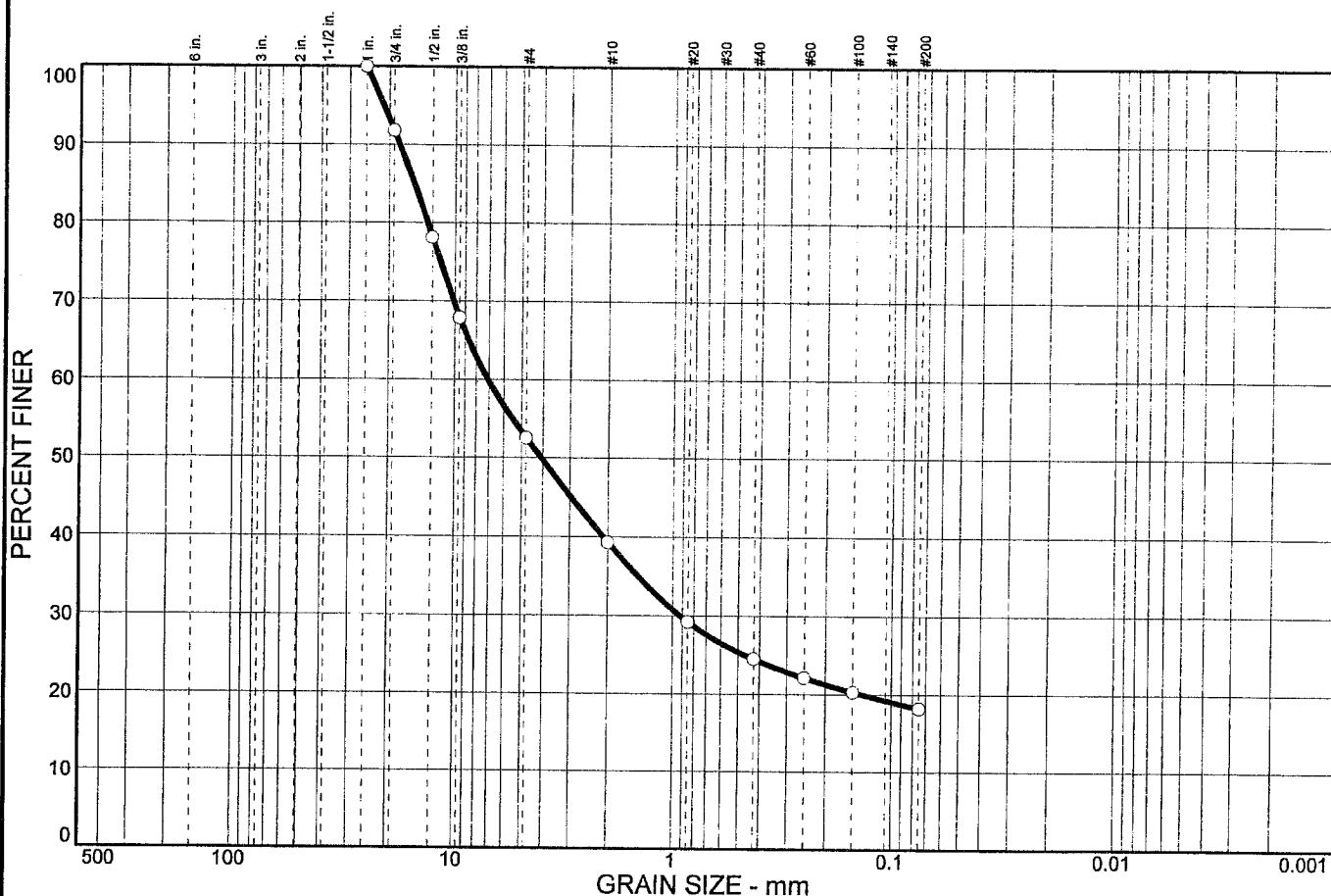

% COBBLES	% GRAVEL		% SAND			% FINES	
	CRS.	FINE	CRS.	MEDIUM	FINE	SILT	CLAY
0.0	8.2	39.3	13.2	14.8	6.3	18.2	

SIEVE SIZE	PERCENT FINER	SPEC.* PERCENT	PASS? (X=NO)
1 in.	100.0		
3/4 in.	91.8		
1/2 in.	78.1		
3/8 in.	67.9		
#4	52.5		
#10	39.3		
#20	29.2		
#40	24.5		
#60	22.1		
#100	20.3		
#200	18.2		

Material Description

Brown to white Andesite bedrock

Atterberg Limits

PL= LL= PI=

Coefficients

D₈₅= 15.4 D₆₀= 7.09 D₅₀= 4.08
D₃₀= 0.926 D₁₅= D₁₀=
C_u= C_c=

Classification

USCS= Andesite AASHTO=

Remarks

Non-plastic material (will not roll)

* (no specification provided)

Sample No.:
Location:

Source of Sample: TB-2

Date: 06-30-98
Elev./Depth: 18.0 to 18.5

**PEZONELLA
ASSOCIATES, INC.
Reno, Nevada**

Client:
Project: Falcon Ridge Townhouses

Project No: 5334.01-N

Plate 12

Particle Size Distribution Report

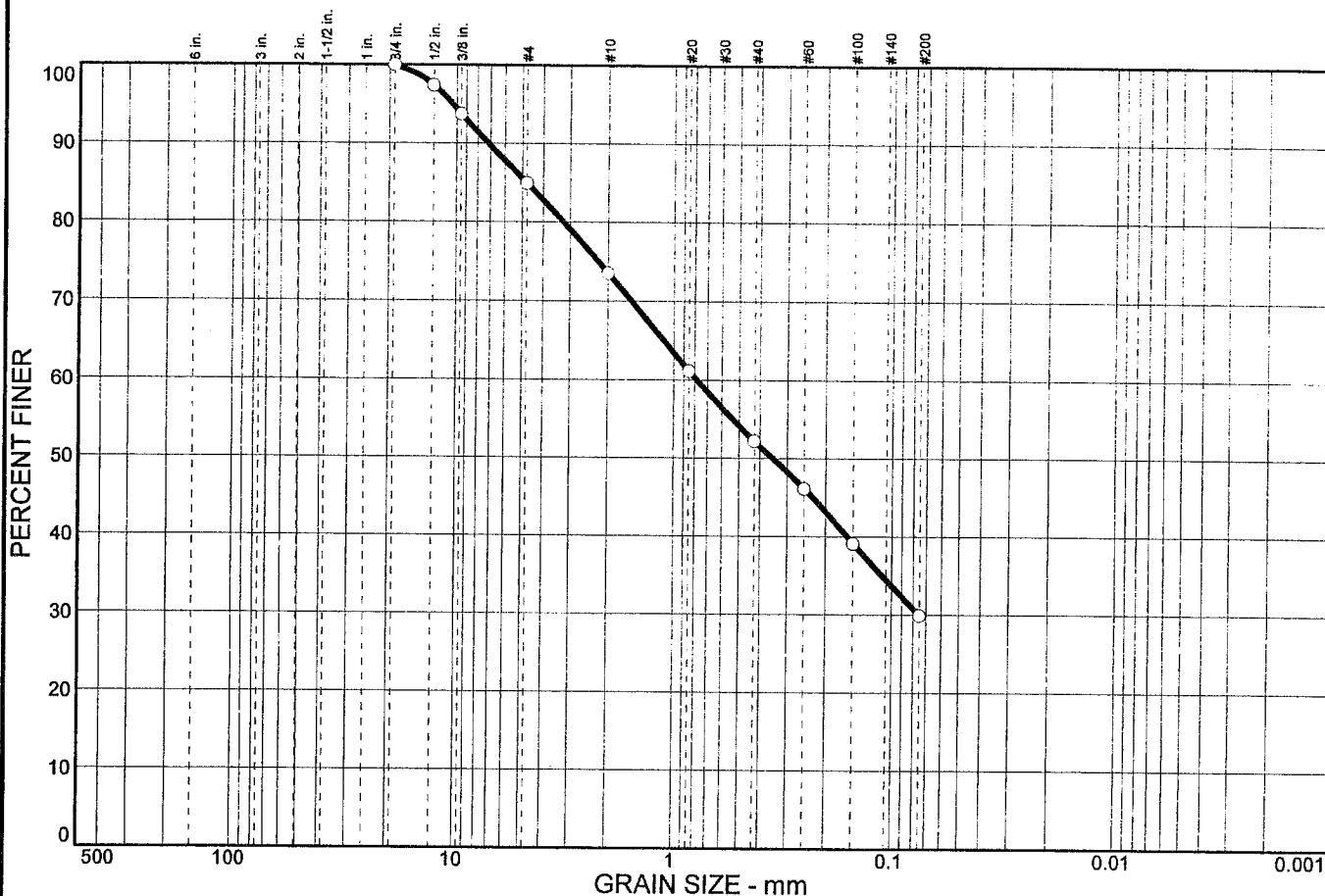

% COBBLES	% GRAVEL		% SAND			% FINES	
	CRS.	FINE	CRS.	MEDIUM	FINE	SILT	CLAY
0.0	0.0	15.1	11.4	21.3	22.3	29.9	

SIEVE SIZE	PERCENT FINER	SPEC.* PERCENT	PASS? (X=NO)
3/4 in.	100.0		
1/2 in.	97.4		
3/8 in.	93.7		
#4	84.9		
#10	73.5		
#20	61.1		
#40	52.2		
#60	46.1		
#100	39.1		
#200	29.9		

Material Description

Brown clayey sand (SC) with gravel

Atterberg Limits

PL= 17 LL= 30 PI= 13

Coefficients

D₈₅= 4.79 D₆₀= 0.785 D₅₀= 0.350
D₃₀= 0.0756 D₁₅= D₁₀=
C_u= C_c=

Classification

USCS= (SC) AASHTO=

Remarks

* (no specification provided)

Sample No.: 914
Location:

Source of Sample: TB-8

Date: 06-09-98
Elev./Depth: 0.0 to 4.0 feet

**PEZONELLA
ASSOCIATES, INC.
Reno, Nevada**

Client:
Project: Falcon Ridge Townhouses

Project No: 5334.01-N

Plate 13

SAMPLE LOCATION : TB-1 @ 0.0 to 4.0 feet

SOIL TYPE : BROQN SANDY CLAY (CH) with gravel

EXPANSION INDEX:	<u> 100.3 </u>
POTENTIAL EXPANSION:	<u> EXPANSIVE </u>

When tested in accordance with ASTM D-4829, the classification of potentially expansive soils is based on the IBC Section 1802.3.2 and is summarized in the following table.

EXPANSION INDEX (EI)	POTENTIAL EXPANSION
0 - 20	Non-expansive
> 20	Expansive

REMARKS :

Expansion Index was calculated by using $E_{I_{meas}}$ within 40% & 60% moisture content. This test provides an index to the expansion potential of compacted soil when inundated with distilled water. This test was performed in accordance with ASTM test procedure No. D-4829.

Job No. 5334.01-N

CSB 12-28-05



**PEZONELLA
ASSOCIATES, INC.**

EXPANSION INDEX
FALCON RIDGE TOWNHOUSES
WASHOE COUNTY, NEVADA

Plate No.
17

R-VALUE TEST REPORT

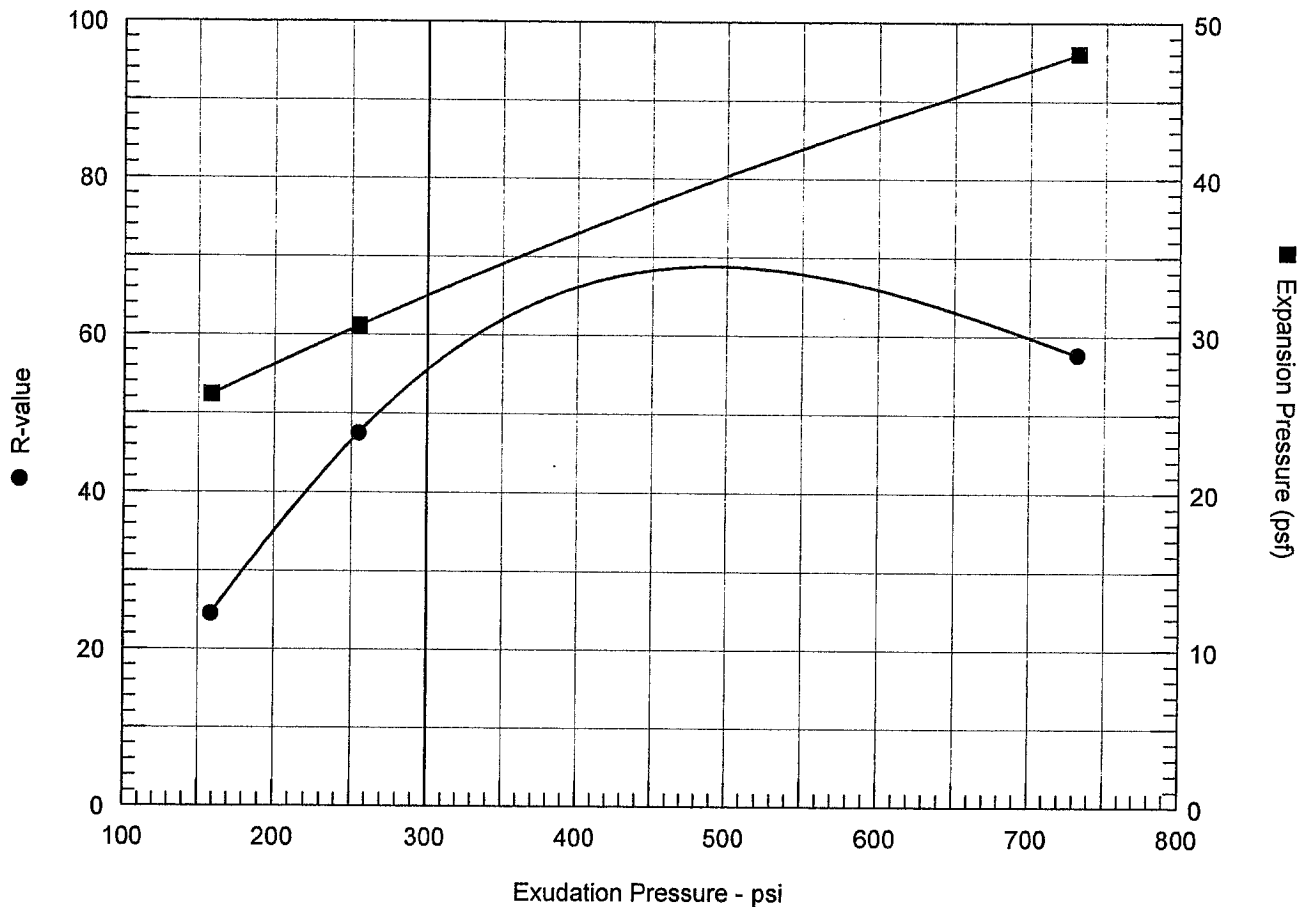

Resistance R-Value and Expansion Pressure - ASTM D 2844

No.	Compact Pressure psi	Density pcf	Moist. %	Expansion Pressure psf	Horizontal Press. psi @ 160 psi	Sample Height in.	Exud. Pressure psi	R Value	R Value Corr.
1	300	125.1	12.4	26	120	2.70	159	22	25
2	300	119.0	10.3	48	69	2.68	732	53	58
3	300	131.7	11.0	31	88	2.70	255	42	47

Test Results	Material Description
<p>R-value at 300 psi exudation pressure = 56</p> <p>Exp. pressure at 300 psi exudation pressure = 32 psf</p>	<p>Brown clayey sand (SC) with gravel</p>
<p>Project No.: 5334.01-N</p> <p>Project: Falcon Ridge Townhouses</p> <p>Source of Sample: TB-8 Depth: 0.0 to 4.0 feet</p> <p>Sample Number: 914</p> <p>Date: 12/22/2005</p>	<p>Tested by:</p> <p>Checked by: CSB</p> <p>Remarks:</p>
<p>R-VALUE TEST REPORT</p> <p>PEZONELLA ASSOCIATES, INC.</p>	

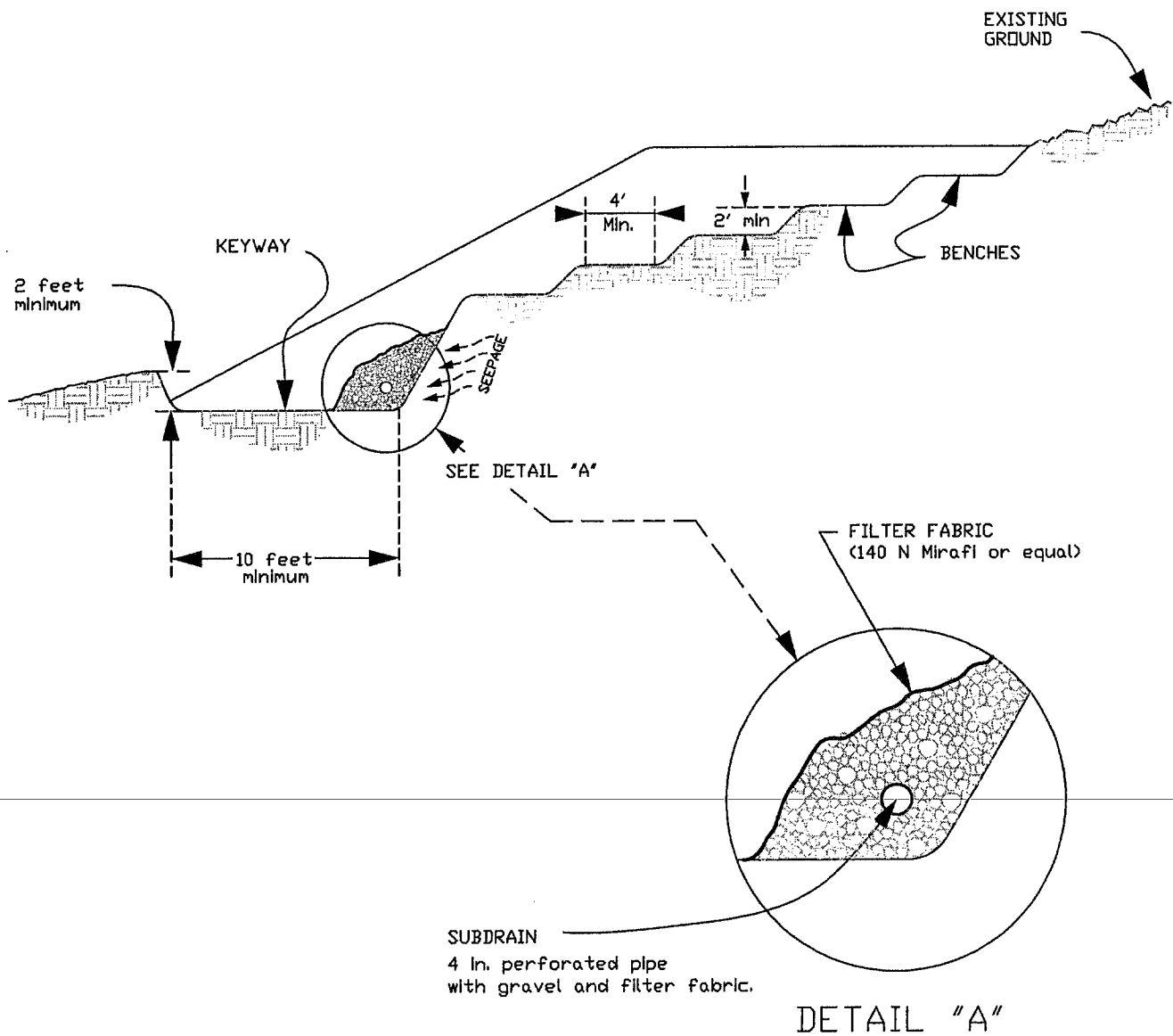

NOTE: This detail applies when existing ground slopes are 5:1 and steeper.

Not to Scale

Job No. 5334.01-N

DETAIL FOR FILLING ON SLOPES

CMB /appr./12-28-05

 **Pezonella Associates, Inc**
Consulting Engineers
520 Edison Way Reno, Nevada 89502
PHONE (775) 866-8686 FAX (775) 866-8042

FALCON RIDGE TOWNHOUSES
WASHOE COUNTY, NEVADA

Plate No.
19

WTM19-004
EXHIBIT F

**SPECIFICATIONS FOR
SITE PREPARATION AND EARTHWORK SPECIFICATION
PROPOSED
FALCON RIDGE TOWNHOUSES
WASHOE COUNTY, NEVADA**

1.0 GENERAL

- 1.1 Scope - The work performed under these specifications shall include clearing, stripping, removal of unsuitable materials, preparation of native soils, excavation, placement and compaction of on-site and imported fill material to grades shown on the approved mass grading plan.
- 1.2 Structural Zones - Structural zones are defined as the area 24 inches below and laterally away from exterior flatwork and pavement subgrades. Only approved structural material may be utilized within structural zones.
- 1.3 Mass Zones - Mass zones are defined as all areas outside the structural zones. In general, materials which do not meet the requirements for select or structural fill may be used in mass zones with the prior approval of the Geotechnical Engineer (or his representative in the field) or governing agency.

2.0 SPECIFICATIONS AND QUALITY ASSURANCE

- 2.1 Standard Specifications - "Standard Specification(s)" shall mean the Standard Specifications for Public Works Construction, in effect at the time of the final plan approval, as adopted and amended by the governing agency. All work within dedicated areas shall be carried out in conformance with the Standard Specifications unless otherwise specified herein.
- 2.2 ASTM - "ASTM" is the designation for the American Society for Testing and Materials.
- 2.3 Percent Relative Compaction - Percent relative compaction is defined as the required in-place unit weight of material, expressed as a percentage of the maximum dry unit weight of the same material, determined by the laboratory procedure outlined in ASTM Test Designation: D 1557.
- 2.4 Optimum Moisture Content - Optimum moisture content is defined as the percent of moisture (by dry weight) corresponding to the maximum dry density of the same material as determined by the laboratory procedure outlined in ASTM Test Designation: D 1557.
- 2.5 Geotechnical Engineer - A Geotechnical Engineer (or his representative in the field), retained by the Owner or Developer, shall provide continuous observations and testing services during site grading operations and periodic inspection during all other construction to enable him to document that all areas (except horizontal and vertical grade control) were constructed in accordance with the accepted project plans, these specifications and the Standard Specifications.

2.6 Soil Density and Quality Tests - Sufficient soil density and quality tests shall be performed and submitted to the Owner or Developer to support the Geotechnical Engineer's documentation of compliance. The cost of re-inspection and re-testing, as a result of unsatisfactory work, shall be deducted from the Contractor's contract price.

3.0 MATERIALS

3.1 General - All fill material shall be free of organic matter or debris and shall be approved by the Geotechnical Engineer prior to its use. All fill material shall be submitted to the Geotechnical Engineer (or his representative in the field) for testing and approval at least 10 working days in advance of hauling or placement. For consideration within the text of these specifications, soils generated by grading will be classified as on-site and native soils.

3.2 Structural Fill Material - Structural fill material shall be used in structural zones and shall be approved by the Geotechnical Engineer (or his representative in the field) and be free of organic matter or debris and conform with requirements included in the latest edition of *Standard Specifications for Public Works Construction*:

<u>Sieve Size</u>	<u>Percent Passing (by dry weight)</u>
4 Inch	100
3/4 Inch	70 - 100
No. 40	15 - 70
No. 200	5 - 25

Liquid Limit = 40 Maximum
Plasticity Index = 12 Maximum
Resistance Value = 30 Minimum

- 3.3 Rock Fill - Rock fill is defined as any material with more than 30 percent retained on the 3/4-inch sieve size. Rock fill is suitable for use in structural zones provided the maximum rock size is less than 6 inches, and with approval by the Geotechnical Engineer (or his representative in the field) or governing agency.
- 3.4 Imported Materials - Imported material shall be approved by the Geotechnical Engineer prior to use. The Contractor shall give at least 10 days notice prior to using the imported material to enable the Geotechnical Engineer (or his representative in the field) to sample and test the material.
- 3.5 Expansive Materials - Where referred to within the text of this report, materials with a potential for expansion are defined as having a Liquid Limit greater than 40, a Plasticity Index greater than 15, an Expansion Index greater than 20 and in excess of 12 percent passing the No. 200 sieve. Materials with Liquid Limits of 40 or less, Plasticity Index of 15 or less, and an Expansion Index less than 20 exhibit very low to negligible potential for expansion.

4.0 SITE PREPARATION

4.1 Clearing and Stripping - Areas to be graded shall be cleared of all debris and mowed of vegetation. Debris shall be removed from the site; however, mowed vegetation may be stockpiled for reuse in landscape areas. Subsequently, as directed by the Geotechnical Engineer (or his representative in the field) any organic laden soils should be stripped and removed from the site or evenly blended with soil and reused in landscape areas. Particular attention should be given to the complete removal of roots associated with trees and shrubs and within drainages. Generally, minor root systems remaining after clearing and stripping may be tilled in-place through the use of a disk harrow or equivalent equipment.

4.2 Wasting of Vegetation and Organics - Mowed vegetation and stripped soils containing roots or organic material may be stockpiled for use in landscape or wasted in designated "non-structural" areas. These materials should be evenly blended with soil, moisture conditioned, placed in 8-inch loose lifts and compacted to provide a surface which is firm. Delineation of any designated "non-structural" areas where vegetation or organics are wasted should be illustrated on the approved plans in order to facilitate future development if proposed.

4.3 Surface Preparation - The surfaces exposed by clearing, stripping or overexcavation should be observed by the Geotechnical Engineer (or his representative in the field) to document that the conditions are as anticipated. Generally, materials remaining after clearing and stripping should be scarified to a depth of 6 inches, moisture conditioned to near optimum (plus 2 to 4 percent over optimum if clayey) and compacted to at least 90 percent relative compaction. If the exposed soils contain abundant oversize material (gravel or cobbles) or are at a suitable and uniform moisture content, the scarifying requirements may be waived by the Geotechnical Engineer (or his representative in the field). Additionally, if the exposed surface contains abundant fine grain particles which can impede attaining the specified compaction, the surface shall be moisture conditioned to near optimum and compacted to provide a surface which is smooth and non-yielding.

4.4 Approval - Before placing any new fill, the Contractor shall obtain the Geotechnical Engineer's (or his representative in the field) approval of the site preparation in each area.

5.0 FILL PLACEMENT AND COMPACTION

5.1 Erosion Control - The Contractor shall take all precautions needed to prevent erosion and conduct earthmoving operations using applicable practices outlined in the most recent edition of the *Handbook of Best Management Practices*.

- 5.2 Structural Fill - All structural fill material shall be moisture conditioned to near optimum and compacted with approved equipment to achieve at least 95 percent relative compaction. Lift thickness will be restricted to a maximum of 8 inches (loose) unless the Contractor can demonstrate his ability to uniformly achieve the required compaction for the entire layer of fill placed. Field density tests shall be performed by the Geotechnical Engineer to determine relative compaction of each lift of fill. These tests shall be performed in the compacted material below the disturbed surface.
- 5.3 Mass Fill - All mass fill material shall be moisture conditioned to near optimum (2 to 4 percent over optimum if clayey) and compacted with approved equipment to achieve at least 90 percent relative compaction. Lift thickness will be restricted to a maximum of 8 inches (loose) unless the Contractor can demonstrate his ability to uniformly achieve the required compaction for the entire layer of fill placed. Field density tests shall be performed by the Geotechnical Engineer to determine relative compaction of each lift of fill. These tests shall be performed in the compacted material below the disturbed surface.

- 5.4 Rock Fill - Rock fill shall be spread in lifts not exceeding 12 inches in uncompacted thickness and placed in such a manner that no voids are present after compacting the layer. Unless otherwise directed by the Geotechnical Engineer, the Grading Contractor shall make at least 4 passes (performance specification) with compactor equipment approved by the Geotechnical Engineer (or his representative in the field) for each lift of rock fill. The final lift thickness and number of compaction passes shall be determined by the Geotechnical Engineer (or his representative in the field) during grading when compaction characteristics of the on-site material is known. Prior to compacting, the lift surface shall be smoothed evenly with bladed equipment. Oversized rock (exceeding 6 inches in diameter) shall be removed from the lift surface.
- 5.5 Recompaction - Where the field moisture and density tests indicate that the required moisture content and/or compaction of any layer of fill or portion thereof has not been attained, the particular layer or portion shall be reconditioned to a suitable moisture content and recompacted to the required density prior to placing additional fill material. The Contractor shall be responsible for placing and compacting approved fill material in accordance with these specifications. Should the Contractor fail to meet the compaction requirement, he shall reduce the rate of haul, furnish additional spreading, watering, mixing, and/or compaction equipment, and make other adjustments necessary to produce a satisfactorily compacted fill.

- 5.6 Seasonal Limits - No fill material shall be placed, spread or rolled while it is frozen or thawing or during unfavorable weather conditions. When the work is interrupted by seasonal runoff, heavy rain or snow, fill operations shall not be resumed until the Geotechnical Engineer (or his representative in the field) indicates that the moisture content and density of the previously placed fill are as specified. If any surface or layer becomes frozen, earthwork construction cannot proceed until it is allowed to thaw. The Earthwork Contractor shall obtain approval from the Geotechnical Engineer (or his representative in the field) of each lift prior to placement of subsequent fill.
- 5.7 Slopes - All permanent cut and fill slopes shall be constructed with a maximum inclination of two horizontal to one vertical (2:1). Where fill is to be placed on natural slopes of 5:1 or steeper, keying and benching shall be provided along the fill/native soil interface. A keyway, located at the base of the slope, shall be at least 2 feet in depth (or into competent material) and 10 feet in width. The face of the slope should be planted with dense-rooted, rapid growing vegetation. A perforated pipe should be installed within the keyway area to allow for drainage of any migrating (seepage) water. The pipe should extend the length of the keyway and daylight at a suitable low point to allow for disposal. The pipe should be completely encapsulated with crushed, 3/4-inch gravel and a filter fabric (i.e. Mirafi 140 N or equal) material should be placed above the gravel layer prior to placing fill material (see attached Plate 19).

- 5.8 Slope Height and Bench Width - In general, individual slopes shall not be taller than 15 feet in height, and all benches shall be at least 5 feet in width. A 3-foot-wide rock lined drainage swale with positive drainage, sufficient to divert runoff and suspended material down and away from the slope should be installed at the top of all slopes and on individual benches. Protective fencing should be considered at the very top of all to contain any oversize aggregate which may become dislodged and/or to discourage activity along the slopes.
- 5.9 Finish -The Contractor shall overfill and trim the face of all fill slopes or compact them to provide a firm surface, free of loose soil that would be subject to erosion and sloughing. To further minimize erosion potential and future maintenance, upon completion of grading, all two to one (2:1) should be protected, in general, with an 8- to 18-inch layer of rip rap stabilization. Where two to one (2:1) slopes less than 15 feet in height and all three to one (3:1) or flatter slopes are proposed, the face of the slope should be planted (via hydroseed or hydromulch) with dense-rooted, rapid growing vegetation. All slopes should be evaluated by the Geotechnical Engineer to document that the conditions are as anticipated and that slope height and bench widths are appropriate.
- 5.10 Slope Rip Rap - Rip rap material should consist of well graded 6- to 12-inch angular rock fragments from a competent (sound) source, exhibit a minimum specific gravity of at least 2.2 and an absorption of less than 4 percent.